



OSBOURNE

Carrier for NVIDIA® AGX ORIN Module

User Manual



Revision No	Release Date	Comments
0.21	12/05/2022	Initial Release
0.3	01/05/2023	Added Commercial IO details and connector callout details

**FOR TECHNICAL SUPPORT
PLEASE CONTACT:**

Email: support@diamondsystems.com

© Copyright 2023
Diamond Systems Corporation
www.diamondsystems.com

Contents

1	Important Safe Handling Information	4
2	Introduction	6
2.1	Osbourne Product Overview	6
2.2	Osbourne Ordering Guide	7
2.3	Product Photos	8
2.4	AGX Orin Modules Overview.....	9
3	Functional Overview	10
3.1	Processor Modules	10
3.2	Power Supply Specifications	10
3.3	Backup Battery	10
3.4	Ethernet Ports.....	10
3.5	Display	11
3.6	Camera Serial Interface (CSI)	11
3.7	Audio Interface.....	11
3.8	Serial Ports	11
3.9	PCIe/USB 3.2/UFS Link Routing Controllers	11
3.9.1	PCIe Minicard Socket.....	11
3.9.2	USB.....	11
3.9.3	PCIe M.2 M-Key Socket.....	12
3.9.4	M.2 E-Key Socket.....	12
3.9.5	PCIe x16 Connector.....	12
3.10	Digital I/O	12
3.11	CAN	12
3.12	Utility	12
3.13	LED Indicators	12
4	Functional Block Diagram	13
4.1	Baseboard Block Diagram	13
4.2	AGX Orin Series Module Block Diagram.....	14
5	Mechanical Drawing	15
6	Connector and Jumper Location	17
6.1	Jumper Selection	18
6.1.1	Serial Port Termination Jumper Selection (JP1).....	18
6.1.2	DIO Jumper Selection (JP2).....	18
6.1.3	Configuration Jumper Selection (JP3).....	18
7	Connector Pinout Specifications	19
7.1	Main I/O Connector (J4)	19
7.2	Camera (J8).....	22
7.3	PCIe Mini Card Socket 1 (J12).....	24
7.4	PCIe Mini Card Socket 2 (J13).....	25
7.5	PCIe Connector (J5).....	26
7.6	M.2 M-Key PCIe SSD Socket (J3).....	28
7.7	M.2 E-Key Socket (J7).....	29
7.8	RGMIID Adapter Connector (J9).....	30
7.9	Auxiliary Power In (J14).....	31
7.10	Fan Connector (J2).....	31
7.11	Auxiliary Power Out (J6).....	31
7.12	MCU Programming Header (J10).....	32
8	I/O Connector List.....	32
9	Commercial IO BOARD	33
9.1	Commercial I/O Board Connectivity	33

9.2	Block Diagram for Commercial I/O Board	33
9.2.1	<i>Mechanical Drawings for Commercial I/O Board</i>	34
9.2.2	<i>Connector and Jumper Location</i>	34
9.2.3	<i>Jumper Selection</i>	35
9.3	Functional Overview	35
9.3.1	<i>Power Supply</i>	35
9.3.2	<i>Ethernet</i>	35
9.3.3	<i>Display</i>	35
9.3.4	<i>Audio</i>	35
9.3.5	<i>Serial Ports and DIO</i>	35
9.3.6	<i>Serial Ports and CAN</i>	35
9.3.7	<i>USB</i>	35
9.3.8	<i>Utility</i>	36
9.4	Connector Pinout Specification	37
9.4.1	<i>Power In (J17)</i>	37
9.4.2	<i>Main I/O Connector (J1)</i>	37
9.4.3	<i>HDMI (J12)</i>	37
9.4.4	<i>Two Dual USB Port (J13, J14)</i>	38
9.4.5	<i>1G Ethernet + 10G Ethernet (J10)</i>	39
9.4.6	<i>Audio (J2)</i>	40
9.4.7	<i>Serial Ports/DIO (J16)</i>	40
9.4.8	<i>CAN/Serial Ports (J11)</i>	41
9.4.9	<i>Utility (J3)</i>	42
9.4.10	<i>Battery Connector (J4)</i>	42
9.4.11	<i>Push Buttons</i>	42
9.4.12	<i>Remote control Power connector (J9)</i>	43
9.4.13	<i>Miscellaneous header (J5)</i>	43
10	Connector Information	44
10.1	Connector Table	44
11	B2B 1G Ethernet Board Connector.....	45
11.1.1	<i>Mechanical Drawing</i>	45
12	Specifications.....	46
13	Limited Warranty.....	47

1 IMPORTANT SAFE HANDLING INFORMATION



WARNING!

ESD-Sensitive Electronic Equipment

Observe ESD-safe handling procedures when working with this product.

Always use this product in a properly grounded work area and wear appropriate ESD-preventive clothing and/or accessories.

Always store this product in ESD-protective packaging when not in use.

Safe Handling Precautions

Diamond Systems boards are designed with complex circuitry and electronic components that are ESD-sensitive. This increases the likelihood of the boards incurring accidental damage during handling, installation, and connection to other equipment.

It is highly recommended that the following precautionary measures and best practices be observed in sequential order:

- Wear an anti-static Wristband/Strap or/and an antistatic Lab Coat or/and Rubber-soled shoes.
- Spread anti-static mats over the table or work surface or/and anti-static mats on the floor.
- Unpack components and remove them from their anti-static bags only when they are ready to be used.
- Avoid ungrounded surfaces such as plastic, carpets, floors, or tables, in the work area.
- Handle boards by the edges and their metal mounting brackets. Avoid touching components on the boards and the edge connectors that connect to expansion slots.

The following information describes common causes of failure found on boards and components returned to Diamond Systems for repair. It is provided as a guideline to avoid accidental damage.

ESD Damage: This type of damage is typically impossible to detect because there is no visual sign of failure or damage. In this type of damage, the board eventually stops functioning because of some defective components. Usually, the failure can be identified, and the chip can be replaced.

To prevent ESD damage, always follow proper ESD-prevention practices when handling computer boards.

Damage During Handling or Storage: Physical damage on boards also occur due to mishandling. A common observation is that of a screwdriver slipping on the board during installation, causing a gouge on the PCB surface, cutting signal traces or damaging components.

Another common observation is damaged board corners, indicating the board was dropped. This may or may not cause damage to the circuitry, depending on components located near the edges. Most Diamond System boards are designed with a minimum 25 mils clearance between the board edge and component pad. The ground/power planes are located a minimum of 20 mils from the edge to avoid possible shorting from this type of damage. However, these design rules do not prevent damage in all situations.

Sometimes boards are stored in racks with slots that grip the edge of the board. This is a common practice for board manufacturers. Though Diamond Systems boards are resilient to damages, the components located close to the board edges can be damaged or even knocked off the board if the board lies tilted in the rack.

Diamond Systems recommends that all its boards be stored only in individual ESD-safe packaging units. If multiple boards are stored together, they should be contained in bins with dividers placed between the boards. Do not pile boards on top of each other or cram too many boards within a small location. This can cause damage to connector pins or fragile components.

Bent Connector Pins: This type of problem can be resolved by re-bending the pins to their original shape using needle-nose pliers.

The most common cause of a bent connector pin is when the board is pulled off a stack by tugging it at angles from one end of the connector to the other, in an effort to release it off the stack. Tugging the board off the stack in this manner can bend the pin(s) significantly.

A similar situation can occur when pulling a ribbon cable off a pin header. If the pins are bent too severely, bending them back can cause them to weaken or break. In this case, the connector must be replaced.

Power Damages: There are various causes of power-specific damages that can occur while handling the board. Some common causes such as –a metal screwdriver tip slipping, or a screw dropping onto the board while it is powered-up, causes a short between a power pin and a signal pin on a component.

These faults can cause over-voltage/power supply problems besides other causes described below.

To avoid such damages, assembly operations must be performed when the system is powered off.

Power Supply Wired Backwards: Diamond Systems power supplies and boards are not designed to withstand a reverse power supply connection. This will destroy almost all ICs connected to the power supply. In this case, the board will likely be irreparable and must be replaced. A chip destroyed by reverse or excessive power will often have a visible hole or show some deformation on the surface due to vaporization inside the package.

Overvoltage on Analog Input: If a voltage applied to an analog input exceeds the power specification of the board, the input multiplexer and/or parts behind it can be damaged. Most Diamond Systems boards will withstand an erroneous connection of up to 36V on the analog inputs, even when the board is powered off, but not on all boards, and not under all conditions.

Overvoltage on Analog Output: If an Analog output is accidentally connected to another output signal or a power supply voltage, the output can be damaged. On most Diamond boards, a short circuit to ground on an analog output will deter any damage to the board.

Overvoltage on Digital I/O Line: If a Digital I/O signal is connected to a voltage above the maximum specified voltage, the digital circuitry can be damaged. The acceptable voltage range, on most Diamond Systems boards connected to digital I/O signals is 0-5V, with overvoltage protection up to 5.5V (-0.5 to 5.5V). Overvoltage beyond this limit can damage the circuitry.

Other considerations are Logic Signals, which are typically generated between 12V to 24V.

If a Digital I/O Line of 12V to 24V is connected to a 5V logic chip, the chip will be damaged, and the damage could extend to other chips in the circuit.

IMPORTANT! Always check twice before Powering Up!

2 INTRODUCTION

2.1 Osbourne Product Overview

Osbourne is a Jetson AGX Orin module-based board with rich graphics and camera input capability. Osbourne board converts Jetson AGX Orin module into a complete embedded system by providing interface circuitry, I/O connector for all the major features of the module, camera interface, power supply and additional I/O capability.

Osbourne Base Board Bring your next-gen products to life with the world's most powerful AI computer for energy-efficient autonomous machines. The modules deliver up to 275 TOPS of AI performance with power configurable between 15W and 60W. Jetson Orin modules provide the ideal solution for a new age of Robotics.

The baseboard is the latest product from Diamond Systems to integrate the newly released Standalone NVIDIA AGX Orin System on Module (SoM) Series:

- AGX Orin 32GB
- AGX Orin 64 GB

Feature Description and Connector Type

<i>Feature</i>	<i>Description</i>	<i>Connector Type</i>
Power	7V-20V wide input supply	Signal Terminated to 150 Position RA Connector Header (J4)
RTC	3V power input for RTC functionality	Signal Terminated to 150 Position RA Connector Header (J4)
Ethernet	1G/2.5G/5G/10G Multi Mode Gigabit Ethernet without on board Magnetics 10/100/1000Mbps through RGMII adapter board without on board Magnetics	Signal Terminated to 150 Position RA Connector Header (J4)
Mass Storage	2x mPCIe socket	PCIe MiniCard 52 Position (52-Pin-Surface Mount, Right Angle)
	1 M.2 M Key (2280 or 2242) (NVMe) expansion slots (4 lane PCIe Gen 3)	M.2 (Key M) Socket
	1 M.2 E key 2230	67 Position Female M.2 Connector (Surface Mount, Right Angle)
Audio	Via ALC5640 CODEC	Signal Terminated to 150 Position RA Connector Header (J4)
USB	4x USB 2.0, 3x USB 3.2	Signal Terminated to 150 Position RA Connector Header (J4)
Serial Ports	2 x ports Software configurable RS-232/422/485 through SP336 transceivers with bypass option to access TTL signals	Signal Terminated to 150 Position RA Connector Header (J4)
	2x ports fixed RS-232 through SP3243 transceivers with bypass option to access TTL signals	Signal Terminated to 150 Position RA Connector Header (J4)
Display	1x HDMI 2.0a/b directly from the Module	Signal Terminated to 150 Position RA Connector Header (J4)
Camera	4 x4 / 8 x2 lane CSI-2 Camera Interface	Surface Mount 120 Position Connector Receptacle

Digital I/Os	8 Digital IO via I2C to GPIO	Signal Terminated to 150 Position RA Connector Header (J4)
CAN	2x CAN with Non isolated transceivers	Signal Terminated to 150 Position RA Connector Header (J4)
Fan	Active Thermal Solution with PWM & Tach Input	Connector Header Surface Mount 1x4 position
Utility	PWR_BTN, RESET, FORCE RECOVERY, I2C(3.3V), SPI(3.3V)	Signal Terminated to 150 Position RA Connector Header (J4)

Operating System Support

Linux Kernel version 4.4.38; Ubuntu 20.04

Mechanical, Electrical and Environmental Properties

Form-Factor	120mm x 115mm
Cooling Mechanism	Conduction Cooling
Power Input Range	+7 to +20VDC, +18V Typical
Operating Temperature Range	-25°C to +80°C at Thermal Transfer Plate (TTP) surface of Orin Module

2.2 Osbourne Ordering Guide

The table below lists the current and planned part numbers in the Osbourne product family.

OSB-ASY-0131-E1F1	Osbourne system / development kit, includes OSB-BB01 baseboard, AGX Orin 32GB module, OSB-PNL01 commercial I/O adapter, ACC-ETHRGM1 2 nd Ethernet PHY, ACC-HSSTV-01 fan sink, Linux OS installed into Orin module, fully assembled, and tested
OSB-PNL01	Osbourne commercial I/O adapter, Jumper port configuration
OSB-PNL02	Osbourne commercial I/O adapter, fixed port configuration (MOQ)
ACC-ETHRGM1	RGMII Ethernet PHY adapter module
ACC-HSSTV-01	Heat Sink Kit with Fan for AGX Xavier / Orin

2.3 Product Photos

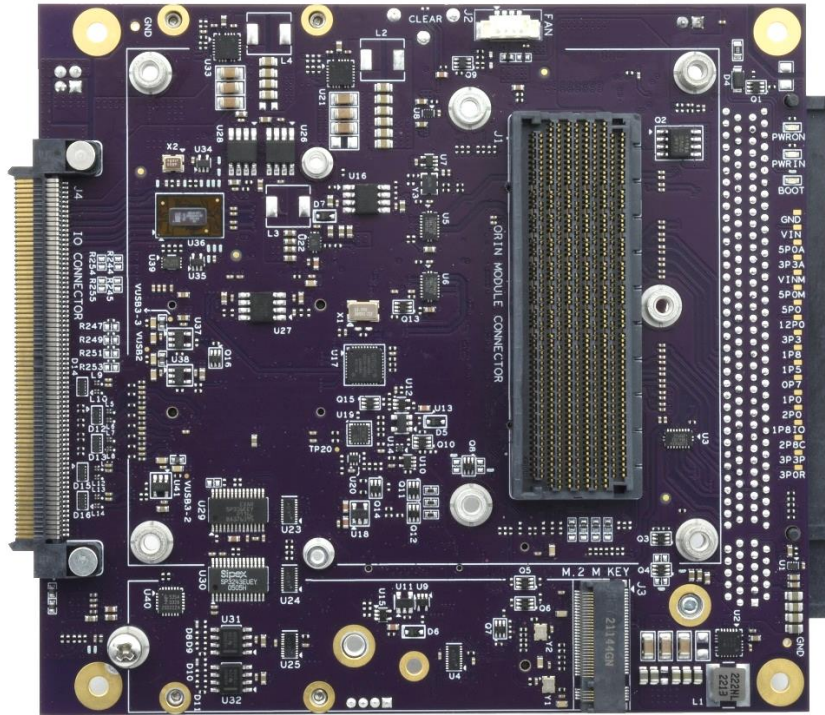

Figure 2-1: Orin module installation side

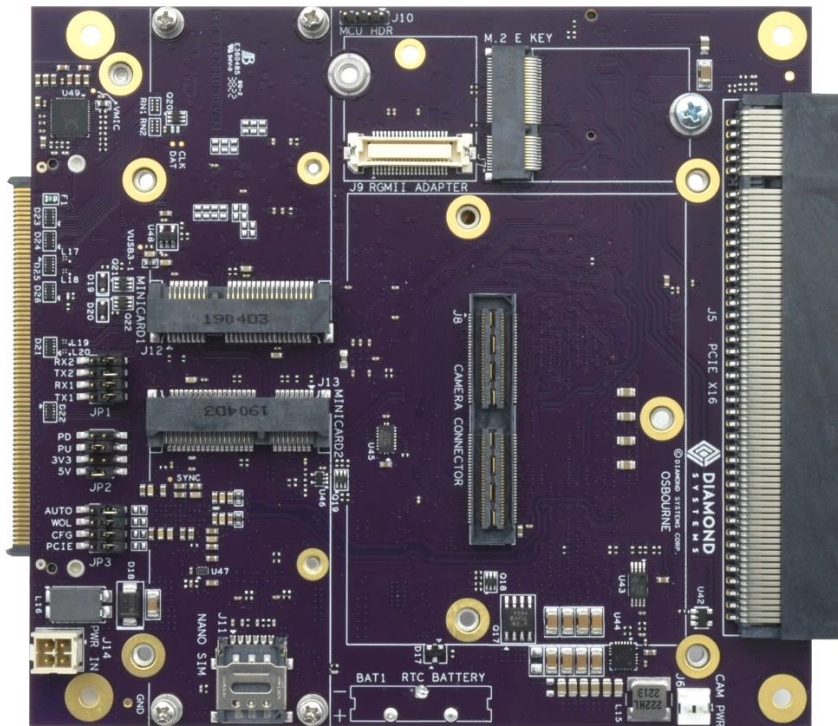

Figure 2-2: I/O expansion side

2.4 AGX Orin Modules Overview

Measuring 100mm x 87mm module, Bring your next-gen products to life with the world’s most powerful AI computer for energy-efficient autonomous machines. Up to 8X the performance of the last generation, 275 TOPS for multiple concurrent AI inference pipelines, and high-speed interface support for multiple sensors make this the ideal solution for applications from manufacturing and logistics to retail and healthcare.

AGX Orin Series Feature Description

<i>Feature</i>	<i>Description</i>	
	<i>AGX Orin 32GB</i>	<i>AGX Orin 64GB</i>
GPU	1792-core NVIDIA Ampere architecture GPU with 56 Tensor Cores	2048-core NVIDIA Ampere architecture GPU with 64 Tensor Cores
AI Performance	200 TOPS	275 TOPS
GPU Max Frequency	939 MHz	1.3 GHz
CPU	8-core Arm® Cortex®-A78AE v8.2 64-bit CPU 2MB L2 + 4MB L3	12-core Arm® Cortex®-A78AE v8.2 64-bit CPU 3MB L2 + 6MB L3
CPU Max Frequency	2.2 GHz	2.2 GHz
Memory	32GB 256-bit LPDDR5 204.8GB/s	64GB 256-bit LPDDR5 204.8GB/s
Video Encode	1x 4K60 (H.265) 3x 4K30 (H.265) 6x 1080p60 (H.265) 12x 1080p30 (H.265)	2x 4K60 (H.265) 4x 4K30 (H.265) 8x 1080p60 (H.265) 16x 1080p30 (H.265)
Video Decode	1x 8K30 (H.265) 2x 4K60 (H.265) 4x 4K30 (H.265) 9x 1080p60 (H.265) 18x 1080p30 (H.265)	1x 8K30 (H.265) 3x 4K60 (H.265) 7x 4K30 (H.265) 11x 1080p60 (H.265) 22x 1080p30 (H.265)
Power	15W - 40W	15W - 60W
Networking	1x GbE 1x 10GbE	
Storage	64GB eMMC 5.1	
DL Accelerator	2x NVDLA v2	
DLA Max Frequency	1.4 GHz	
Vision Accelerator	1x PVA v2	
Camera	Up to 6 cameras (16 via virtual channels*) 16 lanes MIPI CSI-2 D-PHY 2.1 (up to 40Gbps) C-PHY 2.0 (up to 164Gbps)	
USB	3x USB 3.2 Gen2 (10 Gbps) 4x USB 2.0	
Display	1x 8K60 multi-mode DP 1.4a (+MST)/eDP 1.4a/HDMI 2.1	
Other I/O	4x UART, 3x SPI, 4x I2S, 8x I2C, 2x CAN, PWM, DMIC & DSPK, GPIOs	
PCIe	Up to 2 x8 + 1 x4 + 2 x1 (PCIe Gen4, Root Port, & Endpoint)	
Mechanical	100mm x 87mm 699-pin Molex Mirror Mezz Connector Integrated Thermal Transfer Plate	

3 FUNCTIONAL OVERVIEW

The following section provides functional details of the key sub-systems implemented on the baseboard.

3.1 Processor Modules

The baseboard supports Jetson™ AGX Orin Series modules.

Jetson AGX Orin module with up to 275 TOPS and 8X the performance of the last generation for multiple concurrent AI inference pipelines, plus high-speed interface support for multiple sensors, Jetson Orin modules provide the ideal solution for a new age of Robotics. 4nos of M3 4mm standoffs are provided on the module side for fixing the AGX Orin module.

3.2 Power Supply Specifications

The board can be powered from wide input voltage range of +7V to +20V, typically 18V. Supply input should be greater than 15 V if PCIe x16 card is being used.

Maximum allowable reflected ripple, measured at the voltage input connector is 50mV p-p.

All required supply voltages for the board derived from the +(7Vto 20V) input. These power supplies are sized to support the highest capacity on-board memory and have enough reserve capacity to support the below add-on features.

Power Requirements for Supplementary Features

VIN	12 V	5V	3.3V	Feature
5.4A		6A		Jetson Orin Module (50W)
			1.5A	M.2 2280 SSD
			2.6A	Minicards (1.3A per Module)
			1A	M.2 E key
		3A		USB3.2 Ports (1A per Port)
		1A		USB2.0 Ports (0.5A per Port)
		0.5A	0.5A	Camera circuit
	4A		2A	X16 PCIe

3.3 Backup Battery

An onboard 2032 vertical coin battery holder is provided. The board can boot and function normally without a backup battery as well. The backup voltage signal is also connected to IO connector to connect external backup battery for rugged application. RTC of Orin module backup voltage of 3V with 1.8V to 3.46V max is required.

3.4 Ethernet Ports

The board offers Two ethernet port one supports 1G and other supports the 10G ethernet speed.

10G Ethernet port derived using MGBE interface from Orin module using 10G ethernet PHY. Onboard magnetics are NOT provided. LED signals provided for Link, Activity, and Speed Indication

The 10/100/1000 Ethernet port is implemented from the RGMII adapter board. Onboard magnetics are NOT provided. LED signals are provided for Link, Activity, and Speed Indication.

3.5 Display

The board offers one HDMI/DP video output option. The HDMI/DP port is directly from the Module and made available on the I/O connector board connector. All the common choke and ESD protection circuitry are provided on the baseboard. I2C level shifting, and load switch need to be on the IO board.

3.6 Camera Serial Interface (CSI)

Osbourne baseboard includes a 120-pin (2 × 60, 0.5 mm pitch) camera expansion connector matching exactly to the Development kit connector. The connector used on the board is a Samtec QSH-060-01-H-D-A. The mating connector is a Samtec QTH-060-0x-H-D-A (x is for the height). The expansion connector includes interface options for multiple CSI DPHY or CPHY cameras. Refer to the Jetson AGX Orin Camera Module Hardware Design Guide for more information.

CSI up to 4 × 4 lane or 6 × 2 lane

CAM_I2C, Clock and Control GPIOs for the cameras

I2C (2x in addition to CAM_I2C)

Off the shelf add-on board from E-con systems or other vendors could be plugged on to the DB connector to support the 4x 4 lane camera or 6 dual lane cameras OR customer can develop their own daughterboard based on the requirement.

Refer to Section [Camera Installation Procedures](#) of the Addendum for installation and operation procedures.

3.7 Audio Interface

The design provides audio support from a ALC5640 audio chip. Audio I/O signals include stereo line out and mono/stereo mic in. The audio signals made available on the I/O connector board connector.

3.8 Serial Ports

The board supports up to 4 serial ports from the module. Two numbers of RS232/422/485 ports are derived using single SP336 transceiver. Software control for protocols selection via GPIOs provided. On board jumper option provided to select termination (120 Ohm) for RS232/RS422/RS485 protocols.

Another Two fixed RS232 protocol ports are derived using MAX3243EIPW transceiver. Option to bypass the serial transceiver are provided.

3.9 PCIe/USB 3.2/UFS Link Routing Controllers

The Orin module facilitates multiple high-speed interfaces brought out on the module in two different configurations. The table below shows the mapping of USB3.2/PCIe on Osbourne board. Maximum 3 PCIe ports are supported in Configuration #1. For more information on configuration selection refer [Configuration Jumper Selection](#) section.

3.9.1 PCIe Minicard Socket

The board support one full-size minicard sockets in Configuration #1 and two full-size minicard sockets in configuration #2. Two threaded spacers each are mounted on the board for installing full-size modules. Both the mPCIe sockets derives the USB2.0 interface from a USB2.0 Hub.

Nano sim connector is supported for one of the minicard socket. Board provides 2nos onboard M2 4mm standoff to mount each minicard module. Single M2 3.55mm provided on the opposite of the module to act as a nut for half size minicard.

3.9.2 USB

The board supports 1x USB2.0 via USB 2.0 hub routed to I/O connector. Three numbers of USB3.2 and three USB2.0 ports are also routed to the I/O connector. USB power switch, common choke and ESD protection circuitry are provided on the baseboard. One of the USB3.2 ports is muxed with PCIe for configuration #2.

3.9.3 PCIe M.2 M-Key Socket

The board offers M.2 PCIe based SSD module socket. x4 PCIe lanes from the AGX Orin module is routed to the M.2 M-Key socket. The board supports two module sizes: 2280 & 2242. Onboard M3 4 mm standoff to mount M.2 2280 SSD provided. M3 2mm standoff provided on the opposite of the module to act as nut for 2242 size M.2 M key modules.

3.9.4 M.2 E-Key Socket

An M.2 2230 E-key socket is provided. E key socket supports x1 Lane PCIe interface. PCIe port is shared with SDIO, USB2.0 and I2S interface by default. Three pad option for UART shared with serial port transceiver is supported. Onboard M3 2 mm standoff to mount M.2 E Key 2230 module is provided.

3.9.5 PCIe x16 Connector

A standard PCIe x16 RA connector is provided on the baseboard to support x8 PCIe interface. This port is shared with the one of the minicard socket and can be selected based on Jumper JP3. For more detail on Jumper selection Refer [Configuration Jumper Selection](#) Section.

3.10 Digital I/O

The board provides 8x digital I/O's, which are individually configurable as an output or input. Digital I/Os are realized using an I2C GPIO expander. The expander device is accessible on the I2C address 0x22. The I/Os are routed to the I/O connector. On board ESD protection is provided.

Provision is to select the DIO Voltage level of 3.3/5V and configure Pull up and pull down through the Jumper JP2 is provided. Refer [DIO Jumper Selection](#) for more detail.

3.11 CAN

The board provides two CAN interface from the AGX Orin module to the I/O connector. MCP2551T-I/SN CAN transceiver is used with baud rates support from 60 kbaud up to 1 Mbaud.

3.12 Utility

Power button, Force recovery, Reset, SPI and I2C signals are connected to the I/O connector for additional I/O expansion when required.

3.13 LED Indicators

The board provides the following LED indicators. All LEDs are located near to board edge or their respective features. All LEDs are labeled in silkscreen with their function

Position	Description
PWRIN	Green LED for Power IN
PWRON	Green LED for Power Good indication.
BOOT	Green LED for successful system boot

4 FUNCTIONAL BLOCK DIAGRAM

4.1 Baseboard Block Diagram

The following Block Diagram illustrates the key functional blocks of the baseboard with integrated NVIDIA AGX Orin Series Module.

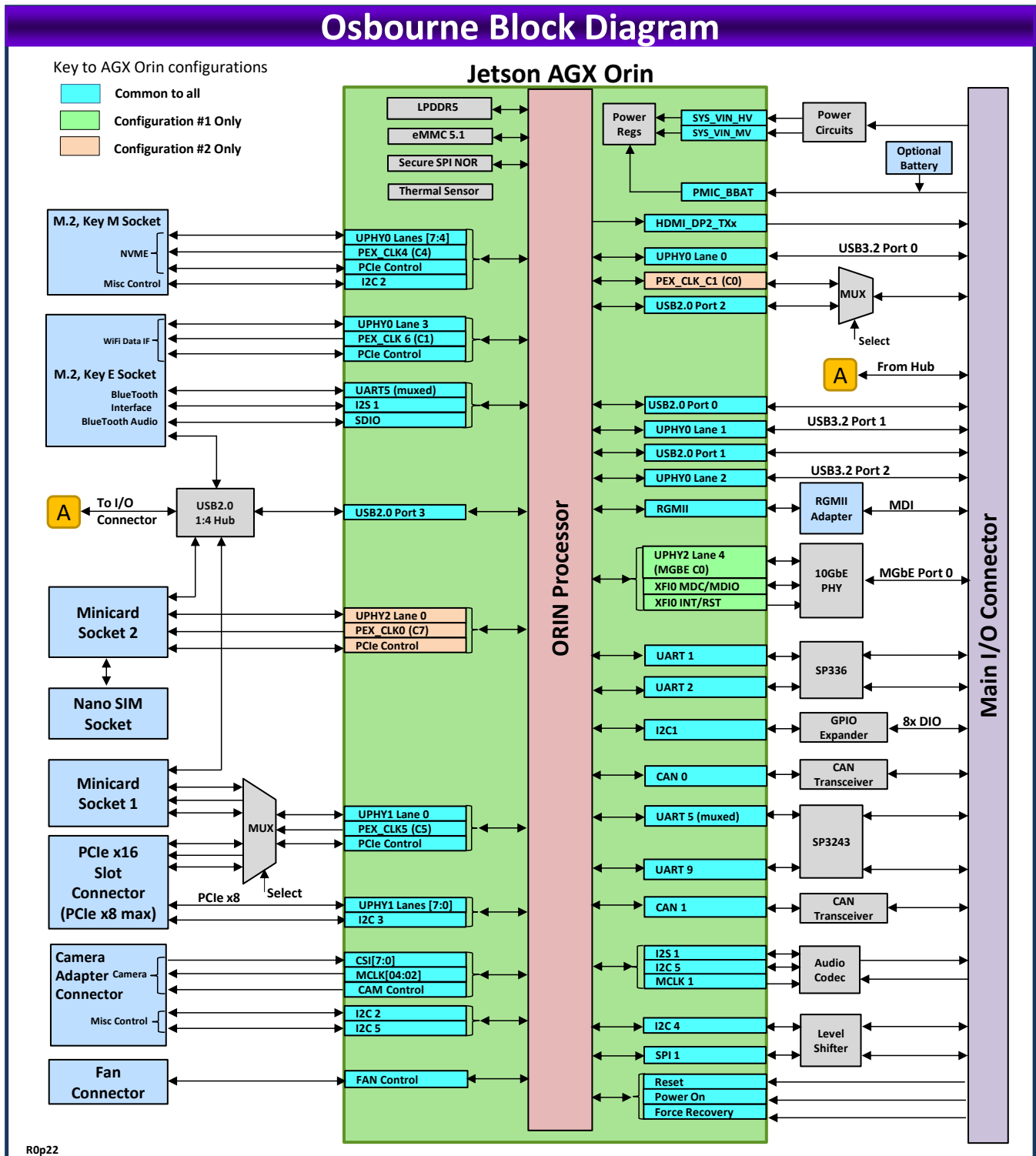

Figure 4-1: Baseboard Functional Block Diagram

4.2 AGX Orin Series Module Block Diagram

The following Block Diagram illustrates a high-level view of the AGX Orin Series components. The ports are broken out through the carrier board.

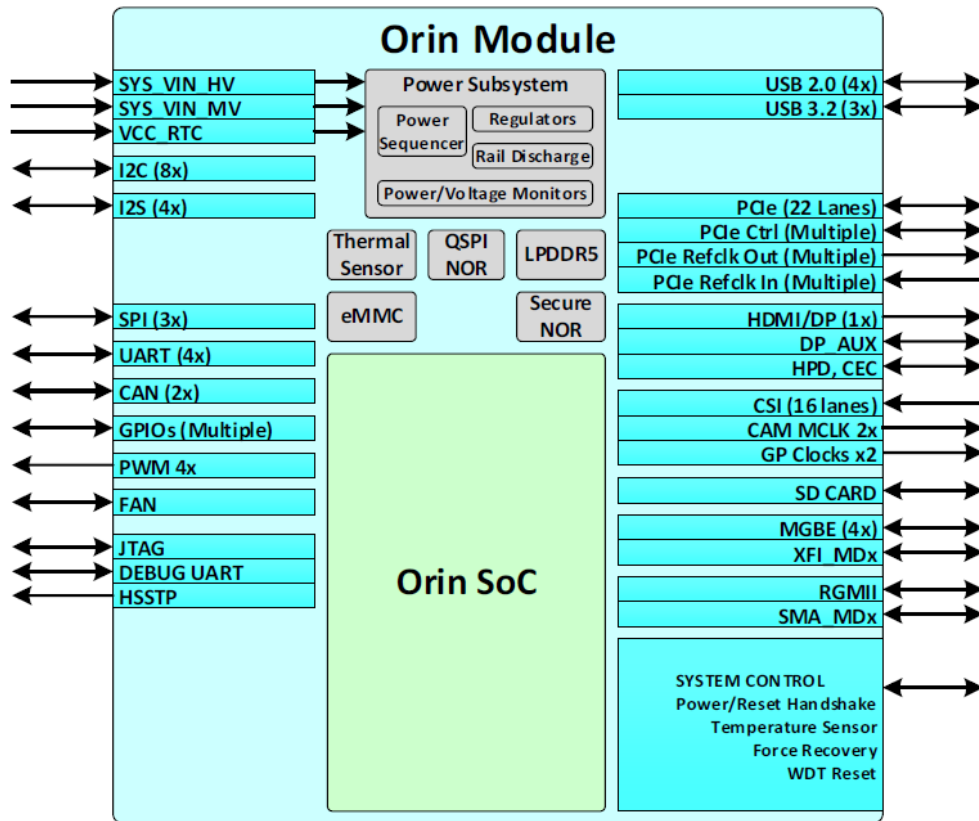

Figure 4-2: AGX Orin Series Module Functional Block Diagram

5 MECHANICAL DRAWING

Below Figures Depict the Top and Bottom Mechanical view of the Baseboard.

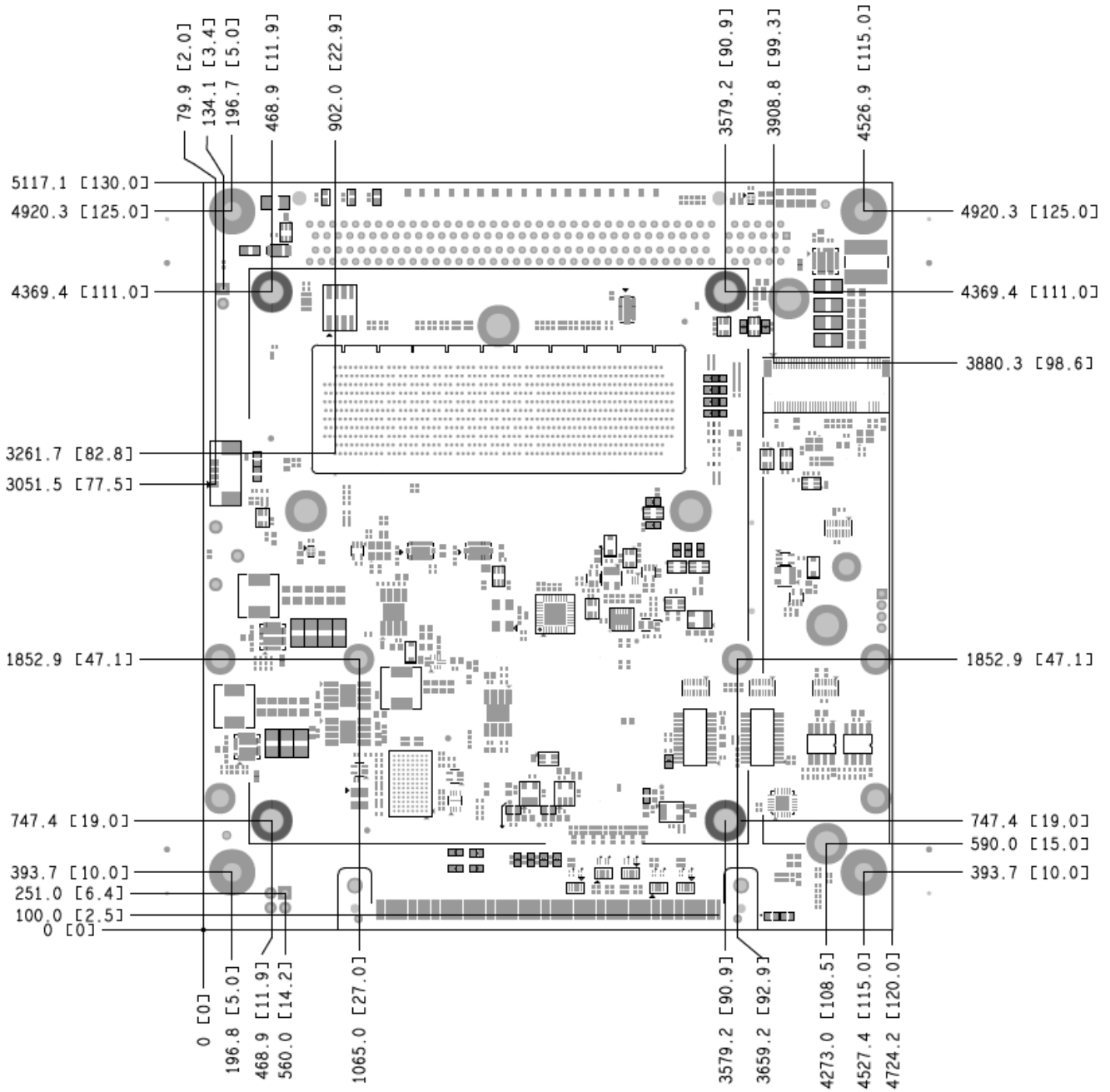

Figure 5-1: Baseboard Mechanical Top View

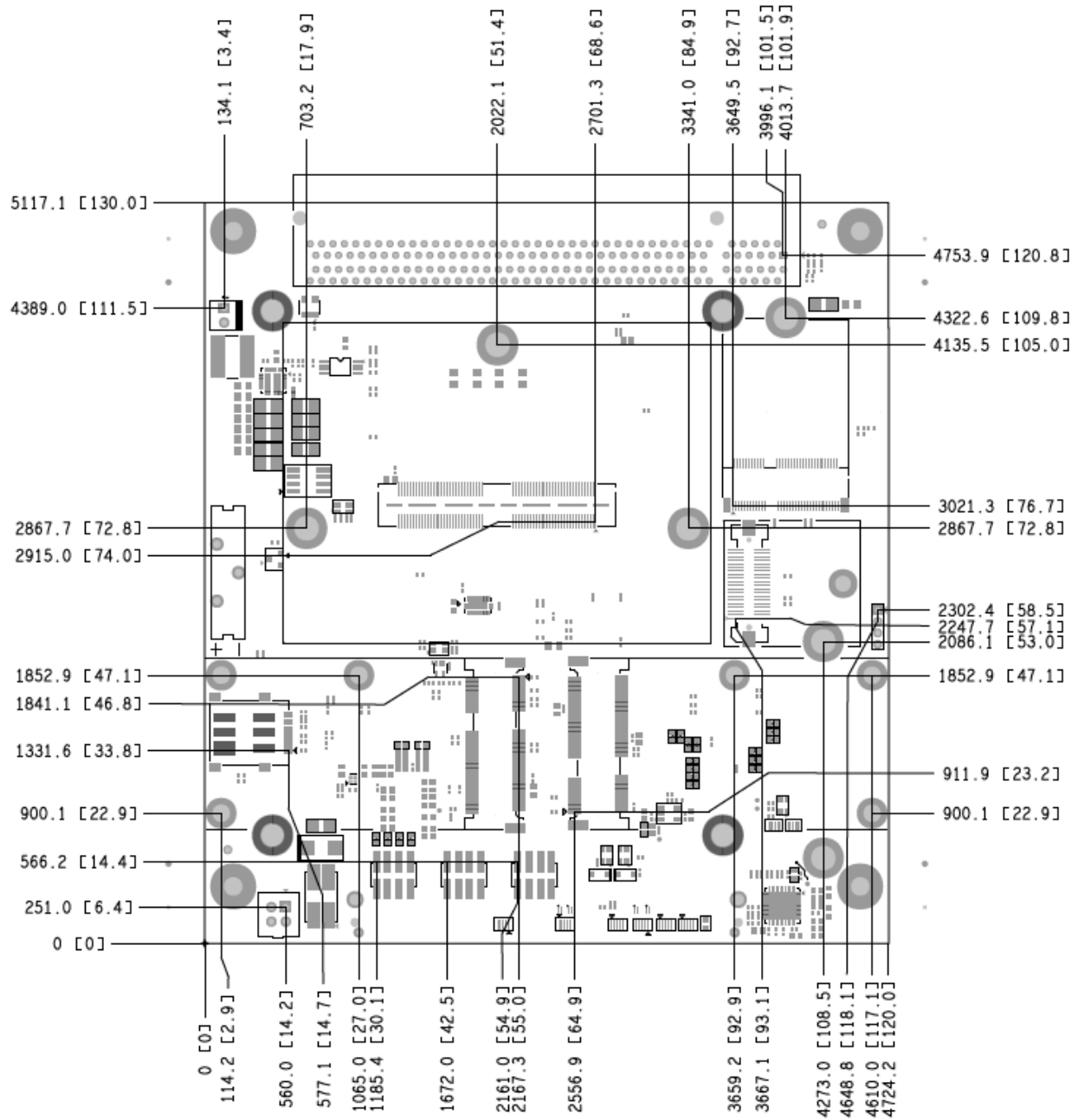

Figure 5-1: Baseboard Mechanical Bottom View

6 CONNECTOR AND JUMPER LOCATION

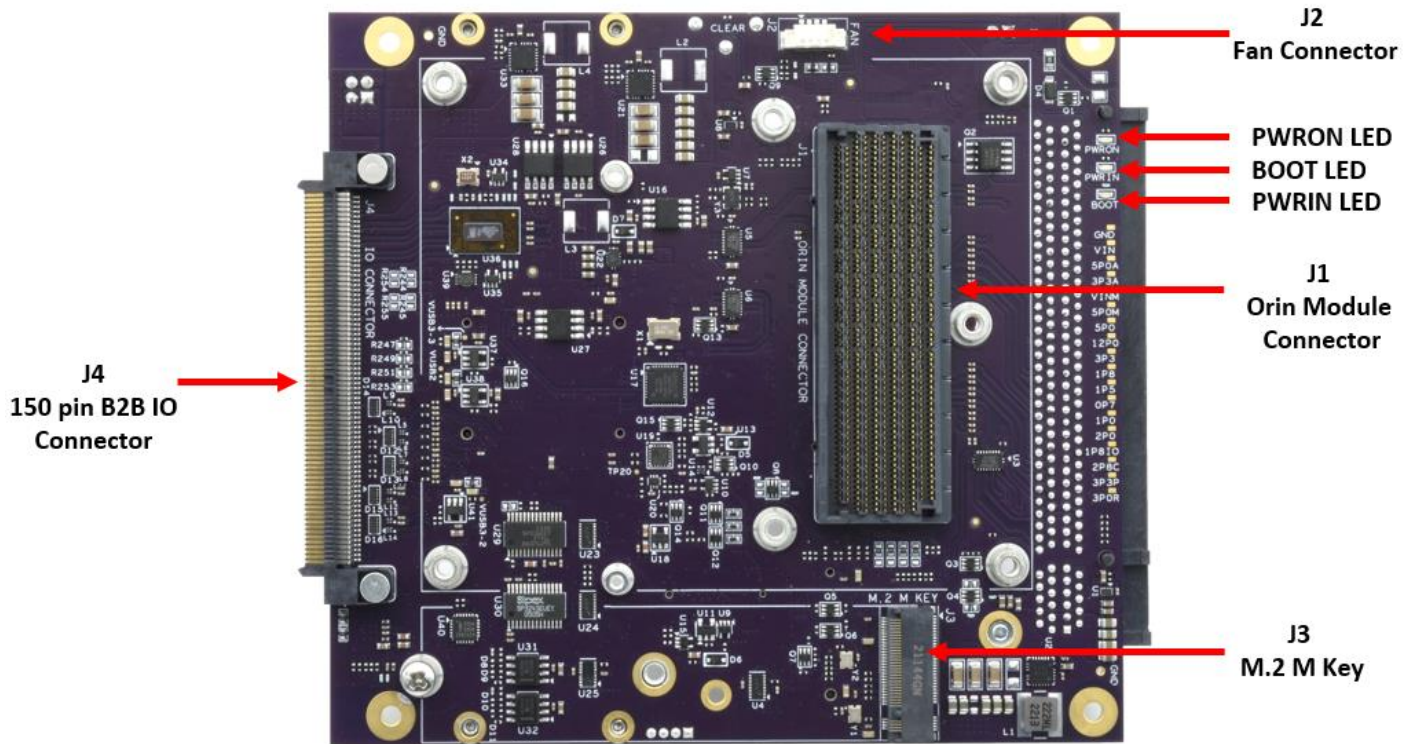

Figure 6-1: Orin module installation side

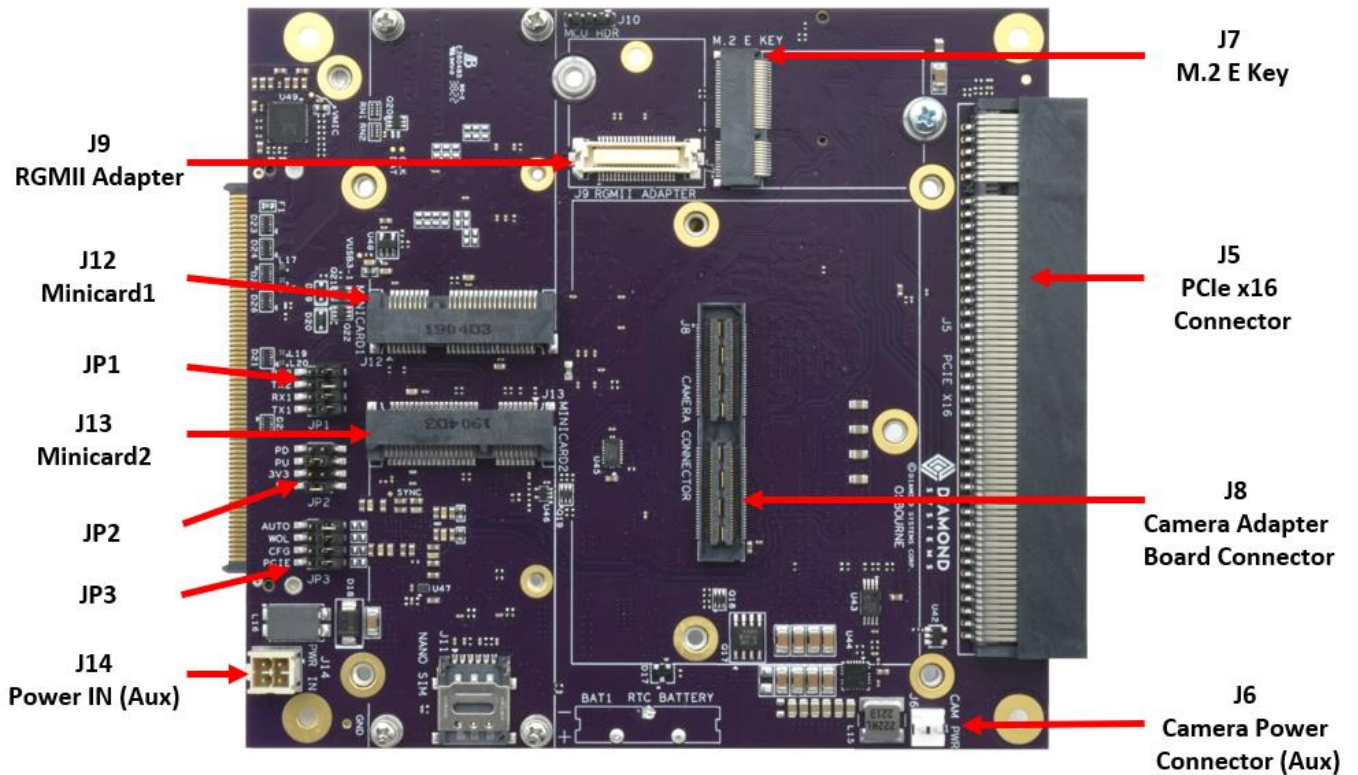

Figure 6-2: I/O expansion side

6.1 Jumper Selection

The Jumper blocks on the Osbourne baseboard can be configured to enable/disable or alter the default signal routing settings on the circuit, using Jumper shunts.

The following table describes the Jumper Blocks on the baseboard.

Jumper	Description
JP1	Serial Termination Enable/Disable
JP2	DIO voltage selection/DIO push pull selection
JP3	PCIe/Minicard selection, Configuration, WOL, Auto Power Selection

6.1.1 Serial Port Termination Jumper Selection (JP1)

JP1 Jumpers Configuration are provided enable and disable the termination of serial ports1-2.

Position	Function	IN	OUT
TX1	121E Termination Enabled for SER1 TX RS-485/RS-422 Mode	Enabled	Disabled*
RX1	121E Termination Enabled for SER1 RX RS-485/RS-422 Mode	Enabled	Disabled*
TX2	121E Termination Enabled for SER2 TX RS-485/RS-422 Mode	Enabled	Disabled*
RX2	121E Termination Enabled for SER2 RX RS-485/RS-422 Mode	Enabled	Disabled*

***Default Mode**

6.1.2 DIO Jumper Selection (JP2)

JP2 Jumpers are provided to select the voltage level and Pullup/pull down configuration of the DIO. By default, the DIOs are 3.3 Volare pulled down. The configuration is as shown below:

Position	Function	IN	OUT
5V	DIO Voltage Level	5V	
3V3	DIO Voltage Level	3.3V*	
PU	DIO Pull up Enable	Enabled	Disabled
PD	DIO Pull down Enable	Enabled*	Disabled

***Default Mode**

Note: Make sure 5V and 3V3 Jumper are not IN at same time.

6.1.3 Configuration Jumper Selection (JP3)

JP3 Jumpers Configuration are provided for various selection and configuration.

Position	Function	IN	OUT
PCIE	x16 PCIe / Minicard2 Selection	x16 PCIE	MINICARD1*
CFG	Boot Configuration	Config #2	Config #1 *
WOL	Wake on LAN	Enabled	Disabled*
AUTO	Auto Power ON	Enabled	Disabled*

***Default Mode**

7 CONNECTOR PINOUT SPECIFICATIONS

7.1 Main I/O Connector (J4)

Most I/O connections are routed to a high density, high-speed I/O connector located on the front edge of the board. A variety of I/O connector boards may be designed based on the application requirements. A connector board using commercial type connectors and oriented in line with the carrier board is available as part no. **OSB-PNL01**.

Direction w.r.t Osbourne	Voltage Level/Pin Type	Signal Name	Pin#	Pin#	Signal Name	Voltage Level/Pin Type	Direction w.r.t Osbourne
Output	Analog Output	AUDIO_HPOR_HDA	1	2	GND_AUD		Audio Ground
Output	Analog Output	AUDIO_HPOL_HDA	3	4	AUDIO_MIC_L	Analog Signal	
Power	3 V	V_3P0_RTC_CON	5	6	AUDIO_MIC_R	Analog Signal	
Power	5 V	V_5P0_A	7	8	AUDIO_PRSNT_L	1.8 V	Input
Power	3.3 /5.0 V	V_DIO	9	10	GND_DIG		Ground
Bi-directional	3.3 /5.0 V	DIO_PA7	11	12	USB3/PCIE_UPHY_RX0_P	USB2 Diff pair/PCle Diff pair	Input
Bi-directional	3.3 /5.0 V	DIO_PA6	13	14	USB3/PCIE_UPHY_RX0_N	USB2 Diff pair/PCle Diff pair	Input
Bi-directional	3.3 /5.0 V	DIO_PA5	15	16	GND_DIG		Ground
Bi-directional	3.3 /5.0 V	DIO_PA4	17	18	USB3/PCIE_UPHY_TX0_P	USB3 Diff pair/PCle Diff pair	Output
Bi-directional	3.3 /5.0 V	DIO_PA3	19	20	USB3/PCIE_UPHY_TX0_N	USB3 Diff pair/PCle Diff pair	Output
Bi-directional	3.3 /5.0 V	DIO_PA2	21	22	GND_DIG		Ground
Bi-directional	3.3 /5.0 V	DIO_PA1	23	24	USB3_UPHY_RX1_P	USB3 Diff pair	Input
Bi-directional	3.3 /5.0 V	DIO_PA0	25	26	USB3_UPHY_RX1_N	USB3 Diff pair	Input
Power	5 V	V_USB3_1	27	28	GND_DIG		Ground
Bi-directional	USB2 Diff pair	USB2_D1_CH_N	29	30	USB3_UPHY_TX1_P	USB3 Diff pair	Output
Bi-directional	USB2 Diff pair	USB2_D1_CH_P	31	32	USB3_UPHY_TX1_N	USB3 Diff pair	Output
Power	5 V	V_USB3_2	33	34	GND_DIG		Ground
Bi-directional	USB2 Diff pair	USB2_D0_CH_N	35	36	HDMI_DP2_TX0_CON_P	HDMI Diff pair	Output
Bi-directional	USB2 Diff pair	USB2_D0_CH_P	37	38	HDMI_DP2_TX0_CON_N	HDMI Diff pair	Output
Output	1.8 V	GPIO20_DP/HDMI_EN_1P8	39	40	GND_DIG		Ground
Output	Open-Drain, 1.8V (3.3V tolerant)	DP2_AUX_CH_P	41	42	HDMI_DP2_TX3_CON_P	HDMI Diff pair	Output
Bi-directional	Open Drain, 1.8V (3.3V tolerant)	DP2_AUX_CH_N	43	44	HDMI_DP2_TX3_CON_N	HDMI Diff pair	Output
Bi-directional	Open Drain, 1.8V (3.3V tolerant)	HDMI_CEC_CON	45	46	GND_DIG		Ground
Bi-directional	CMOS – 1.8V	DP2/HDMI_HPD	47	48	HDMI_DP2_TX2_CON_N	HDMI Diff pair	Output
Input	RS232 Signal	UART5_CTS_RS232	49	50	HDMI_DP2_TX2_CON_P	HDMI Diff pair	Output
Input	RS232 Signal	UART5_RX_RS232	51	52	GND_DIG		Ground

Output	RS232 Signal	UART5_RTS_RS232	53	54	HDMI_DP2_TX1_C ON_N	HDMI Diff pair	Output
Output	RS232 Signal	UART5_TX_RS232	55	56	HDMI_DP2_TX1_C ON_P	HDMI Diff pair	Output
Input	RS232 Signal	UART3_9_RX_RS232	57	58	GND_DIG		Ground
Output	RS232 Signal	UART3_9_TX_RS232	59	60	USB3_UPHY_RX2_0_P	USB3 Diff pair	Input
Power	5 V	V_USB2_VBUS	61	62	USB3_UPHY_RX2_0_N	USB3 Diff pair	Input
Bi-directional	USB2 Diff pair	USB2_HUB_D4_C H_N	63	64	GND_DIG		Ground
Bi-directional	USB2 Diff pair	USB2_HUB_D4_C H_P	65	66	USB3_UPHY_TX2_0_P	USB3 Diff pair	Output
Power	5 V	V_USB3_3	67	68	USB3_UPHY_TX2_0_N	USB3 Diff pair	Output
Bi-directional	USB2 Diff pair/ PCIe Diff pair	USB2/PCIE_CLK_ CH_N	69	70	GND_DIG		Ground
Bi-directional	USB2 Diff pair/ PCIe Diff pair	USB2/PCIE_CLK_ CH_P	71	72	NC		
Bi-directional	CAN Differential Pair	CAN1_L	73	74	NC		
Bi-directional	CAN Differential Pair	CAN1_H	75	76	NC		
Bi-directional	CAN Differential Pair	CAN0_L	77	78	NC		
Bi-directional	CAN Differential Pair	CAN0_H	79	80	NC		
Input	RS232/ RS422/ RS485	CTS2/RX2_N	81	82	NC		
Input	RS232/ RS422/ RS485	RX2/RX2_P	83	84	NC		
Bi-directional	RS232/ RS422/ RS485	RTS2/TX2_N/RX2_N	85	86	NC		
Bi-directional	RS232/ RS422/ RS485	TX2/TX2_P/RX2_P	87	88	NC		
Input	RS232/ RS422/ RS485	CTS1/RX1_N	89	90	NC		
Input	RS232/ RS422/ RS485	RX1/RX1_P	91	92	NC		
Bi-directional	RS232/ RS422/ RS485	RTS1/TX1_N/RX1_N	93	94	GND_DIG		Ground
Bi-directional	RS232/ RS422/ RS485	TX1/TX1_P/RX1_P	95	96	GBE_MDI0_P	1G Eth differential Pair	Bi-directional
Bi-directional	I2C data; 3.3 V	I2C_GP8_DAT_3P3	97	98	GBE_MDI0_N	1G Eth differential Pair	Bi-directional
Output	I2C Clock; 3.3 V	I2C_GP8_CLK_3P3	99	100	GND_DIG	1G Eth differential Pair	Ground
Input	3.3 V	BUTTON_POWER_ON_N	101	102	GBE_MDI1_P	1G Eth differential Pair	Bi-directional
Bi-directional	Open Drain, 1.8V	SYS_RST_IN_N	103	104	GBE_MDI1_N	1G Eth differential Pair	Bi-directional
Input	CMOS – 1.8V	FORCE_RECOVERY#	105	106	GND_DIG		Ground
		NC	107	108	GBE_MDI2_P	1G Eth differential Pair	Bi-directional
		NC	109	110	GBE_MDI2_N	1G Eth differential Pair	Bi-directional
Output	Open-Drain, 3.3V	PEX_C1_RST_N	111	112	GND_DIG		Ground

Input	3.3 V	MEM_ERS_GPIO	113	114	GBE_MDI3_P	1G Eth differential Pair	Bi-directional
Output	1.8 V	SER_GPIO_SEL	115	116	GBE_MDI3_N	1G Eth differential Pair	Bi-directional
Output	1.8 V	CAN_SER_SEL2	117	118	GND_DIG		Ground
Output	1.8 V	CAN_SER_SEL1	119	120	MGBE0_PHY_A_P	10G Eth differential Pair	Bi-directional
Output	3.3 V	SPI1_SCK_3P3	121	122	MGBE0_PHY_A_N	1G Eth differential Pair	Bi-directional
Output	3.3 V	SPI1_CS0_3P3	123	124	GND_DIG		Ground
Input	3.3 V	SPI1_MISO_3P3	125	126	MGBE0_PHY_B_P	1G Eth differential Pair	Bi-directional
Output	3.3 V	SPI1_MOSI_3P3	127	128	MGBE0_PHY_B_N	1G Eth differential Pair	Bi-directional
Output	1.8 V	KSZ_LED2	129	130	GND_DIG		Ground
Output	1.8 V	KSZ_LED1	131	132	MGBE0_PHY_C_N	1G Eth differential Pair	Bi-directional
Output	Open Drain, 20mA	MGBE_LED2	133	134	MGBE0_PHY_C_P	1G Eth differential Pair	Bi-directional
Output	Open Drain, 20mA	MGBE_LED1	135	136	GND_DIG		Ground
Output	Open Drain, 20mA	MGBE_LED0	137	138	MGBE0_PHY_D_P	1G Eth differential Pair	Bi-directional
Power	3.3 V	V_3P3	139	140	MGBE0_PHY_D_N	1G Eth differential Pair	Bi-directional
Ground		GND_DIG	141	142	GND_DIG		Ground
Power		V_VIN	143	144	V_VIN		Power
Power		V_VIN	145	146	V_VIN		Power
Power		V_VIN	147	148	V_VIN		Power
Power		V_VIN	149	150	V_VIN		Power

Connector on Osbourne: Samtec ERM8-075-01-L-D-RA-L-TR

Mating Connector:

ERF8-075-01-L-D-RA-L-TR for in-line connector board

ERM8-075-02.0-L-DV-TR for right angle connector board (part can be changed be based on the mating height)



7.2 Camera (J8)

Osbourne baseboard supports the 2x60 socket header where the CSI lanes from the Orin module are terminated. The pinout matches the Nvidia Orin development kit. Any camera adapter designed for the Orin development kit will work on Osbourne as well.

CSI_0_D0_P	1	2	CSI_1_D0_P
CSI_0_D0_N	3	4	CSI_1_D0_N
GND	5	6	GND
CSI_0_CLK_P	7	8	CSI_1_CLK_P
CSI_0_CLK_N	9	10	CSI_1_CLK_N
GND	11	12	GND
CSI_0_D1_P	13	14	CSI_1_D1_P
CSI_0_D1_N	15	16	CSI_1_D1_N
GND	17	18	GND
CSI_2_D0_P	19	20	CSI_3_D0_P
CSI_2_D0_N	21	22	CSI_3_D0_N
GND	23	24	GND
CSI_2_CLK_P	25	26	CSI_3_CLK_P
CSI_2_CLK_N	27	28	CSI_3_CLK_N
GND	29	30	GND
CSI_2_D1_P	31	32	CSI_3_D1_P
CSI_2_D1_N	33	34	CSI_3_D1_N
GND	35	36	GND
CSI_4_D0_P	37	38	CSI_6_D0_P
CSI_4_D0_N	39	40	CSI_6_D0_N
GND	41	42	GND
CSI_4_CLK_P	43	44	CSI_6_CLK_P
CSI_4_CLK_N	45	46	CSI_6_CLK_N
GND	47	48	GND
CSI_4_D1_P	49	50	CSI_6_D1_P
CSI_4_D1_N	51	52	CSI_6_D1_N
GND	53	54	GND
DVDD_CAM_LV	55	56	DVDD_CAM_LV
DVDD_CAM_LV	57	58	DVDD_CAM_LV
CSI_5_D0_P	59	60	CSI_7_D0_P
CSI_5_D0_N	61	62	CSI_7_D0_N
GND	63	64	GND
CSI_5_CLK_P	65	66	CSI_7_CLK_P
CSI_5_CLK_N	67	68	CSI_7_CLK_N
GND	69	70	GND
CSI_5_D1_P	71	72	CSI_7_D1_P
CSI_5_D1_N	73	74	CSI_7_D1_N
I2C_GP3_CLK	75	76	CAM_ERROR1
I2C_GP3_DAT	77	78	CAM_ERROR2
GND	79	80	GND
V_2P8_CAM	81	82	V_2P8_CAM
V_2P8_CAM	83	84	CAM_ERROR3
CAM_FRSYNC1	85	86	CAM_ERROR4
I2C_GP2_CLK	87	88	MCLK03_CAM1_MCLK
I2C_GP2_DAT	89	90	CAM1_PWDN
MCLK02_CAM0_MCLK	91	92	CAM1_RST
CAM0_PWDN	93	94	MCLK04_CAM2_MCLK
CAM0_RST	95	96	CAM_FRSYNC4
CAM_FRSYNC3	97	98	CAM_FRSYNC2
GND	99	100	GND

CAM_TE_RSV	101	102	VDD_1V8
CAM_INT3	103	104	CAM_INT4
I2C_GP9_CLK	105	106	CAM_INT2
I2C_GP9_DATA	107	108	VDD_3V3
CAM_BACKLIGHT_PWM	109	110	VDD_3V3
CAM_SPI_SCK (NC)	111	112	CAM_SPI_MOSI (NC)
CAM_SPI_CS0 (NC)	113	114	CAM_SPI_MISO (NC)
GND	115	116	GND
CAM_INT1	117	118	VDD_3V3
CAM_VDD_SYS_EN	119	120	VDD_3V3
GND	121	122	GND
GND	123	124	GND
GND	125	126	GND
GND	127	128	GND

Connector on Osbourne: Samtec QSH-060-01-H-D-A-K-TR
 Mating connector: Samtec QTH-060-01-L-D-A or similar (may vary with desired board to board spacing)



7.3 PCIe Mini Card Socket 1 (J12)

All TX/RX signals are with respect to the host. TX on the socket drives RX on the installed module, and RX on the socket is driven by TX on the installed module. MiniCard Socket 1 is muxed with x16 PCIe standard connector. The selection of minicard socket and x16 PCIe is done through the JP3 Jumper. By Default, mPCIe socket is selected.

The two mounting standoffs at the far end of the module installation site are not connected to ground.

PEX_WAKE_N	1	2	+3.3V
NC	3	4	GND
NC	5	6	+1.5V
PEX_C5_CLKREQ_N	7	8	NC
GND	9	10	NC
MPCIE_CLK_N	11	12	NC
MPCIE_CLK_P	13	14	NC
GND	15	16	NC
KEY			
NC	17	18	GND
NC	19	20	MPCIE1_DISABLE#
GND	21	22	PEX_C5_RST_N
UPHY_RX12_MPCIE_N	23	24	+3.3V
UPHY_RX12_MPCIE_P	25	26	GND
GND	27	28	+1.5V
GND	29	30	I2C_GP8_CLK_3P3
UPHY_TX12_MPCIE_N	31	32	I2C_GP8_DAT_3P3
UPHY_TX12_MPCIE_P	33	34	GND
GND	35	36	USB2_HUB_D1_N
GND	37	38	USB2_HUB_D1_P
+3.3V	39	40	GND
+3.3V	41	42	NC
GND	43	44	NC
NC	45	46	NC
NC	47	48	+1.5V
NC	49	50	GND
NC	51	52	+3.3V

Connector part number: TE Connectivity 1759547-1

Mating connector: PCB edge gold fingers



7.4 PCIe Mini Card Socket 2 (J13)

All TX/RX signals are with respect to the host. TX on the socket drives RX on the installed module, and RX on the socket is driven by TX on the installed module. Minicard socket 2 is available in configuration #2 only. The selection of Configuration #1 and configuration #2 is done through the JP3 Jumper.

The two mounting standoff at the far end of the module installation site are not connected to ground.

PEX_WAKE_N	1	2	+3.3V
NC	3	4	GND
NC	5	6	+1.5V
PEX_C0_CLKREQ_N	7	8	V_SIM_PWR
GND	9	10	SIM_DATA
PEX_CLK0_N	11	12	SIM_CLK
PEX_CLK0_P	13	14	SIM_RST
GND	15	16	SIM_VPP
KEY			
NC	17	18	GND
NC	19	20	MPCIE2_DISABLE#
GND	21	22	PEX_C0_RST_N
UPHY_RX2_N	23	24	+3.3V
UPHY_RX2_P	25	26	GND
GND	27	28	+1.5V
GND	29	30	I2C_GP8_CLK_3P3
UPHY_TX2_N	31	32	I2C_GP8_DAT_3P3
UPHY_TX2_P	33	34	GND
GND	35	36	USB2_HUB_D3_N
GND	37	38	USB2_HUB_D3_P
+3.3V	39	40	GND
+3.3V	41	42	NC
GND	43	44	NC
NC	45	46	NC
NC	47	48	+1.5V
NC	49	50	GND
NC	51	52	+3.3V

Connector part number: TE Connectivity 1759547-1

Mating connector: PCB edge gold fingers



7.5 PCIe Connector (J5)

All TX/RX signals are with respect to the host. TX on the connector drives RX on the installed card, and RX on the connector is driven by TX on the installed card.

The PCIe signals are muxed with Minicard Socket 1. The Selection of PCIe x16 socket and Minicard through Jumper at JP3 jumper block. Connector used is x16 lane however upto x8 lane PCIe is supported by Nvidia Orin module.

GND	A1	B1	V_12P0
V_12P0	A2	B2	V_12P0
V_12P0	A3	B3	V_12P0
GND	A4	B4	GND
NC	A5	B5	I2C_GP3_CLK_PEX_3V3
NC	A6	B6	I2C_GP3_DAT_PEX_3V3
NC	A7	B7	GND
NC	A8	B8	V_3P3_PEX
V_3P3_PEX	A9	B9	PEX_JTAG_R
V_3P3_PEX	A10	B10	V_3P3
PEX_C5_RST_N_R	A11	B11	PEX_WAKE_N
GND	A12	B12	PEX_C5_CLKREQ_N
PCIE_CLK_P	A13	B13	GND
PCIE_CLK_N	A14	B14	UPHY_TX12_PCIE_P
GND	A15	B15	UPHY_TX12_PCIE_N
UPHY_RX12_PCIE_P	A16	B16	GND
UPHY_RX12_PCIE_N	A17	B17	PCIE_PRSNT#
GND	A18	B18	GND
NC	A19	B19	UPHY_TX13_P
GND	A20	B20	UPHY_TX13_N
UPHY_RX13_P	A21	B21	GND
UPHY_RX13_N	A22	B22	GND
GND	A23	B23	UPHY_TX14_P
GND	A24	B24	UPHY_TX14_N
UPHY_RX14_P	A25	B25	GND
UPHY_RX14_N	A26	B26	GND
GND	A27	B27	UPHY_TX15_P
GND	A28	B28	UPHY_TX15_N
UPHY_RX15_P	A29	B29	GND
UPHY_RX15_N	A30	B30	NC
GND	A31	B31	PCIE_PRSNT#
NC	A32	B32	GND
NC	A33	B33	UPHY_TX16_P
GND	A34	B34	UPHY_TX16_N
UPHY_RX16_P	A35	B35	GND
UPHY_RX16_N	A36	B36	GND
GND	A37	B37	UPHY_TX17_P
GND	A38	B38	UPHY_TX17_N
UPHY_RX17_P	A39	B39	GND
UPHY_RX17_N	A40	B40	GND
GND	A41	B41	UPHY_TX18_P
GND	A42	B42	UPHY_TX18_N
UPHY_RX18_P	A43	B43	GND
UPHY_RX18_N	A44	B44	GND
GND	A45	B45	UPHY_TX19_P
GND	A46	B46	UPHY_TX19_N
UPHY_RX19_P	A47	B47	GND

UPHY_RX19_N	A48	B48	PCIE_PRSNT#
GND	A49	B49	GND
NC	A50	B50	NC
GND	A51	B51	NC
NC	A52	B52	GND
NC	A53	B53	GND
GND	A54	B54	NC
GND	A55	B55	NC
NC	A56	B56	GND
NC	A57	B57	GND
GND	A58	B58	NC
GND	A59	B59	NC
NC	A60	B60	GND
NC	A61	B61	GND
GND	A62	B62	NC
GND	A63	B63	NC
NC	A64	B64	GND
NC	A65	B65	GND
GND	A66	B66	NC
GND	A67	B67	NC
NC	A68	B68	GND
NC	A69	B69	GND
GND	A70	B70	NC
GND	A71	B71	NC
NC	A72	B72	GND
NC	A73	B73	GND
GND	A74	B74	NC
GND	A75	B75	NC
NC	A76	B76	GND
NC	A77	B77	GND
GND	A78	B78	NC
GND	A79	B79	NC
NC	A80	B80	GND
NC	A81	B81	PCIE_PRSNT#
GND	A82	B82	NC

Connector part number: PCIE-164-02-F-D-RA

Mating connector: PCB edge gold fingers



7.6 M.2 M-Key PCIe SSD Socket (J3)

All TX/RX signals are with respect to the host. TX on the socket drives RX on the installed module, and RX on the socket is driven by TX on the installed module. One mounting standoff at the far end of the module installation site are not connected to ground.

GND	1	2	3.3V
GND	3	4	3.3V
UPHY_RX22_N	5	6	MEM_ERS_GPIO
UPHY_RX22_P	7	8	N/C
GND	9	10	LED1#
UPHY_TX22_N	11	12	3.3V
UPHY_TX22_P	13	14	3.3V
GND	15	16	3.3V
UPHY_RX23_N	17	18	3.3V
UPHY_RX23_P	19	20	N/C
GND	21	22	N/C
UPHY_TX23_N	23	24	N/C
UPHY_TX23_P	25	26	N/C
GND	27	28	N/C
UPHY_RX10_N	29	30	N/C
UPHY_RX10_P	31	32	N/C
GND	33	34	N/C
UPHY_TX10_N	35	36	N/C
UPHY_TX10_P	37	38	N/C
GND	39	40	I2C_GP2_CLK
UPHY_RX11_N	41	42	I2C_GP2_DAT
UPHY_RX11_P	43	44	M2M_ALERT_N
GND	45	46	N/C
UPHY_TX11_N	47	48	N/C
UPHY_TX11_P	49	50	PEX_C4_RST_N
GND	51	52	PEX_C4_CLKREQ_N
PEX_CLK4_N	53	54	PEX_WAKE_N
PEX_CLK4_P	55	56	N/C
GND	57	58	N/C
KEY			
N/C	67	68	SUSCLK
NC	69	70	3.3V
GND	71	72	3.3V
GND	73	74	3.3V
GND	75		

Connector part number: Amphenol 10128798-005RLF

Mating connector: PCB edge gold fingers

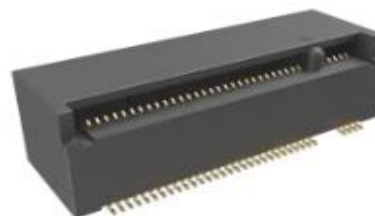

7.7 M.2 E-Key Socket (J7)

All TX/RX signals are with respect to the host. TX on the socket drives RX on the installed module, and RX on the socket is driven by TX on the installed module. One mounting standoff is used at the far end of the module installation site. This standoff is not connected to ground.

GND	1	2	3.3V
USB2_HUB_D2_P	3	4	3.3V
USB2_HUB_D2_N	5	6	NC
GND	7	8	I2S4_SCLK
SDMMC1_CLK	9	10	I2S4_FS
SDMMC1_CMD	11	12	I2S4_DIN
SDMMC1_D0	13	14	I2S4_DOUT
SDMMC1_D1	15	16	NC
SDMMC1_D2	17	18	GND
SDMMC1_D3	19	20	M2E_BT_WAKE
M2E_SDIO_WAKE	21	22	UART5_RX_1P8_M2E
M2E_SDIO_EN	23	32	UART5_TX_1P8_M2E
KEY			
GND	33	34	UART5_CTS#_1P8_M2E
UPHY_TX21_P	35	36	UART5_RTS#_1P8_M2E
UPHY_TX21_N	37	38	NC
GND	39	40	NC
UPHY_RX21_P	41	42	M2E_AP_WAKE_BT
UPHY_RX21_N	43	44	NC
GND	45	46	NC
PEX_CLK6_P	47	48	NC
PEX_CLK6_N	49	50	CLK_32K_M2_E
GND	51	52	PEX_C7_RST_R_N
EX_C7_CLKREQ_N	53	54	BT_RST_N_M2E_CON
PEX_WAKE_N	55	56	W_DISABLE1
GND	57	58	I2C_GP9_DATA_R
NC	59	60	I2C_GP9_CLK_R
NC	61	62	M2E_ALERT_R_N
GND	63	64	NC
NC	65	66	NC
NC	67	68	NC
GND	69	70	NC
NC	71	72	3.3V
NC	73	74	3.3V
GND	75	76	GND
GND	77		

<p>Connector part number: TE Connectivity 2199230-4</p> <p>Mating connector: PCB edge gold fingers</p>	
--	--

7.8 RGMII Adapter Connector (J9)

A B2B connector is provided on the Osbourne board to connect the RGMII adapter board. B2B connector is a 40 pin SMD connector with the below pin out.

	3.3 V	1	2	
	3.3 V	3	4	1.8 V
	GND	5	6	1.8 V
	GND	7	8	GND
RGMII_RD3_1P8		9	10	RGMII_TD0_1P8
RGMII_RD2_1P8		11	12	RGMII_TD1_1P8
RGMII_RD1_1P8		13	14	RGMII_TD2_1P8
RGMII_RD0_1P8		15	16	RGMII_TD3_1P8
RGMII_RX_CTL_1P8		17	18	RGMII_TX_CTL_1P8
RGMII_RXC_1P8		19	20	RGMII_TXC_1P8
	GND	21	22	GND
RGMII_SMA_MDC_1P8		23	24	ENET_RST_1P8
RGMII_SMA_MDIO_1P8		25	26	ENET_INT_1P8
KSZ_LED1		27	28	KSZ_LED2
	GND	29	30	GND
GBE_MDI3_P		31	32	GBE_MDI2_P
GBE_MDI3_N		33	34	GBE_MDI2_N
	GND	35	36	GND
GBE_MDI0_P		37	38	GBE_MDI1_P
GBE_MDI0_N		39	40	GBE_MDI1_N

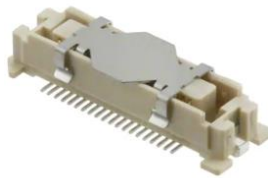
<p>Connector on Osbourne: Molex 0528850474</p> <p>Mating connector: Molex 0550910474</p>	
--	---

7.9 Auxiliary Power In (J14)

By default, voltage input is via the main IO connector. For testing purpose an auxiliary 2x2 IPL1 series power connector is provided. The input voltage range is 7-20VDC.

VIN	1	2	GND
VIN	3	4	GND

Connector part number: IPL1-102-01-L-D-K
Mating connector: Samtec IPD1-02-D-K
Mating Cable: DSC # 6981507



7.10 Fan Connector (J2)

A 4-pin SMD connector is provided to connect FAN for cooling option. Fan connector is on the same side of the Orin module. By default, Fan connector voltage is 5V. Option for 12V is provided.

1	Fan PWM (5V)
2	Fan Tacho input (Open Drain, 1.8V)
3	5V
4	Ground

Connector part number: 53398-0471



7.11 Auxiliary Power Out (J6)

A 2-pin 12V Friction Lock type connector provides 12V power that can be used to power other devices in the system or to provide additional power to an installed camera adapter. The 12V is derived from the external Main input voltage. Note that when 12V is required the main input voltage should be greater than 15V.

User can make a custom cable as required if any camera module requires external 12V apart from the supplies available on the 120pin Camera module connector.

1	12VDC
2	Ground

Connector part number: 53398-0471



7.12 MCU Programming Header (J10)

A 1x4 2mm header is provided to program the power sequencing microcontroller for factory use. Controller binary is same as that in the Orin module development kit.

1	3.3V
2	DATA
3	CLK
4	Ground

Connector part number: Standard single row 2mm TH pin header

8 I/O CONNECTOR LIST

The following table provides a summary of the I/O connectors on the Stevie baseboard.

Function	Manufacturer	Part no.	Description	DSC Mating Cable
Main I/O connector	Samtec	ERM8-075-01-L-D-RA-L-TR	2x75 0.8mm pitch R/A SMD	NA
Camera (x4)	Samtec	QSH-060-01-H-D-A-K-TR	2x60 0.5mm pitch	NA
M.2 PCIe E-Key	TE	2199230-4	Conn M.2 female 67pos 0.020 gold	NA
PCIe Minicard	TE	1759547-1	52-pin Minicard, full size, with PCB mount threaded spacers	NA
M.2 SSD M Key	Amphenol	10128798-005RLF	75-pin M.2 M keyed socket, 2242, with PCB mount threaded spacer	NA
Module Connector	Molex	2034560003	699-pin board-to-board connector, 8mm B2B	NA
x16 PCIe Connector	Samtec	PCIE-164-02-F-D-RA	164 Position Female Connector PCI Express™ Gold 0.039" (1.00mm) Black	NA
B2B connector	Molex	0528850474	40 Position Connector Receptacle, Center Strip Contacts Surface Mount Gold	NA
Fan Connector	Molex	538-53398-0471	4 position SMD 1.25mm vertical header	NA
Camera Power connector	TE	640456-2	Connector Header Through Hole 2 position 0.100" (2.54mm)	NA
Power Connector (Auxiliary)	Samtec	IPL1-102-01-L-D-K	Connector Header Through Hole 4 position 0.100" (2.54mm)	6981507

9 COMMERCIAL IO BOARD

9.1 Commercial I/O Board Connectivity

Commercial I/O board provides access to all the signals available on the 150pin I/O connector to standard HDMI, USB, RJ45, DB9 and RJ11 type connectors.

9.2 Block Diagram for Commercial I/O Board

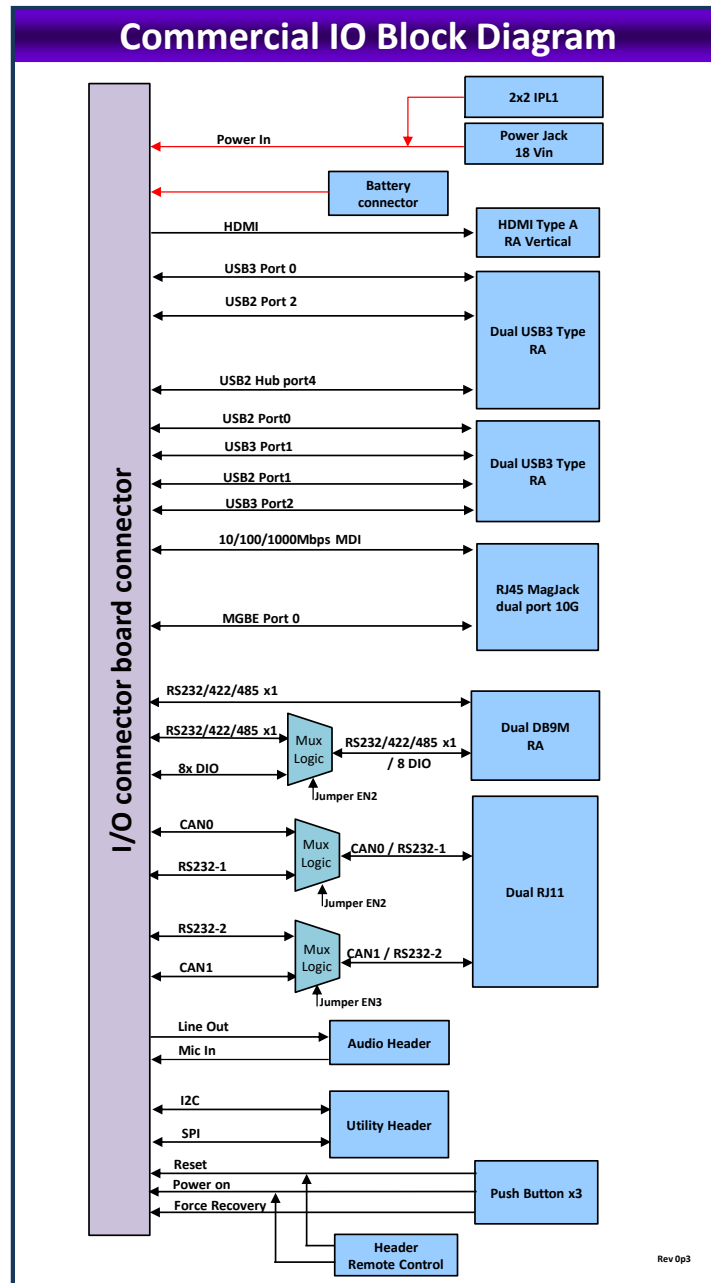

Figure 9-1: Commercial I/O Board Block Diagram

9.2.1 Mechanical Drawings for Commercial I/O Board

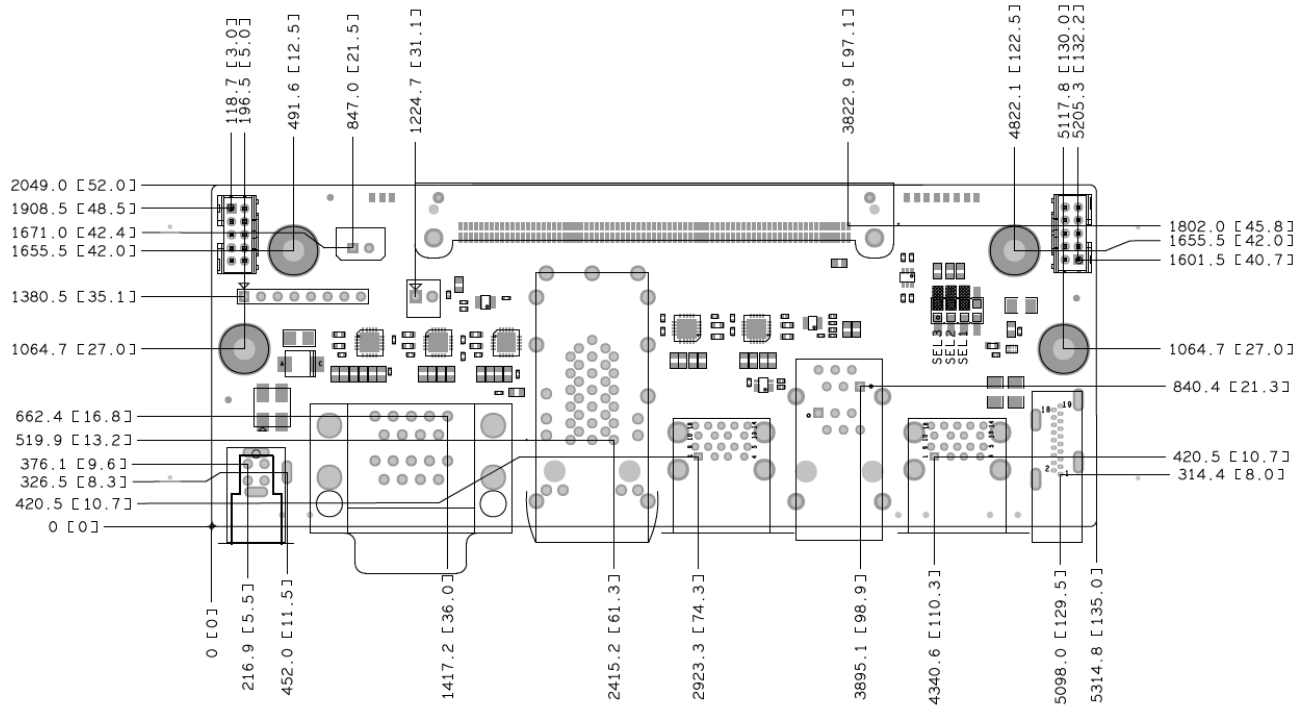

Figure 9-2: Commercial I/O Mechanical outline

9.2.2 Connector and Jumper Location

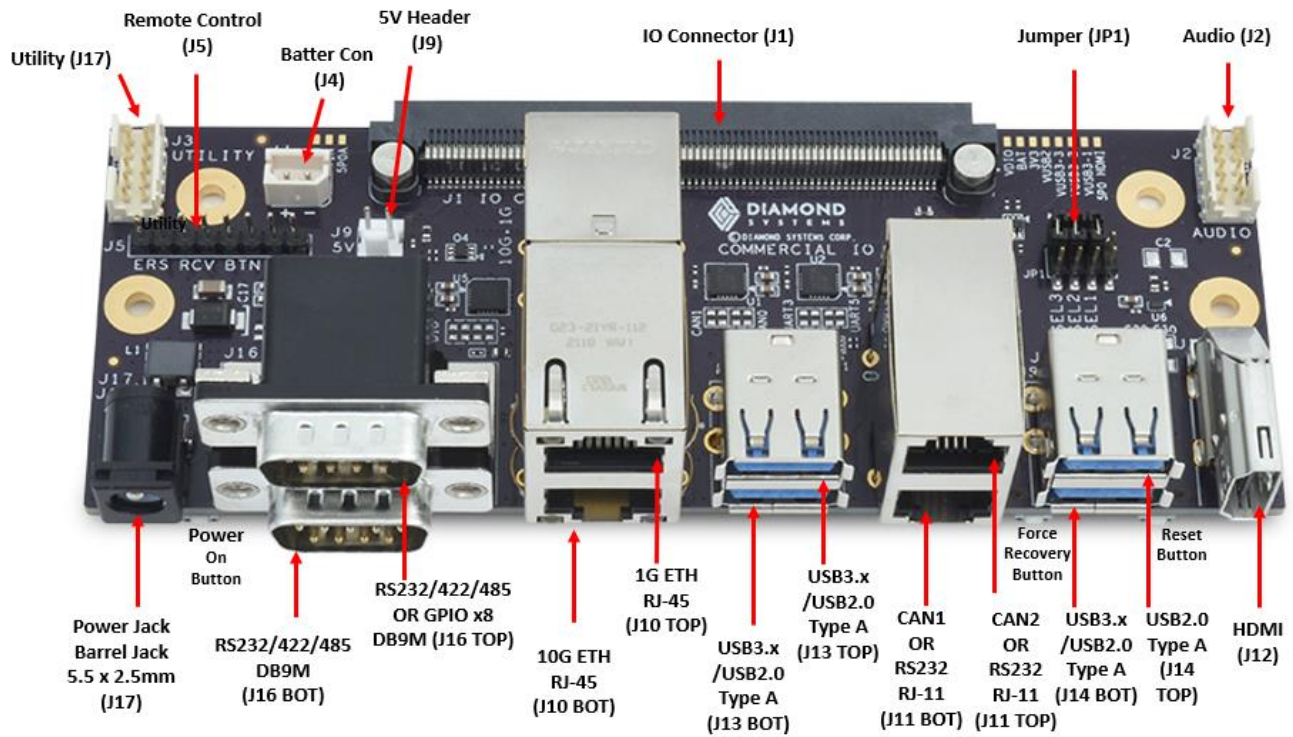

Figure 9-3: Commercial IO Connector locations

9.2.3 Jumper Selection

9.2.3.1 CAN/Serial/DIO Jumper (JP1)

The Jumper block JP1 on the Commercial IO board is used to configure the IO connectors on the front panel to Serial Port/GPIO on DB9M Top port, CAN/Serial Port on RJ11 port. Fixed Configuration board is also based on the ordering part number.

The following table describes the Jumper Block on the Commercial Io board.

Position	Function	IN	OUT
SEL1	Serial/CAN (J11 Bottom Port)	Serial	CAN*
SEL2	Serial/CAN (J11 Top Port)	Serial	CAN*
SEL3	Serial/DIO (J16 Top Port)	Serial	DIO*
*Default Mode			

9.3 Functional Overview

Commercial Panel I/O Board in which all the I/O signals are routed to a 150pin single I/O Connector board with all circuitries included in the main board to have only Passive components and connectors on I/O connector board.

9.3.1 Power Supply

The board can be powered from wide input voltage range of +7V to +20V. Power signals are extended to the I/O connector would be used to power the main Osbourne base board.

Maximum allowable reflected ripple, measured at the voltage input connector is 50mV p-p.

All required supply voltages for the board derived from the +(7V-20V) input. Voltage input should be greater than 15V if PCIe x16 connector to be used on the Osbourne board.

9.3.2 Ethernet

The board has vertically stacked dual RJ45 connector with inbuilt magnetics offers wired connectivity to the ethernet network. The MDI signals of both connectors are routed to the I/O connector. Top Port of RJ45 Connector provide 1G speed and Bottom Port provides 10G ethernet speed.

9.3.3 Display

The board offers one type A HDMI2.0 a/b video output connector. The HDMI signals are routed directly from the Module and made available on the I/O connector board connector. All the signal termination and protection circuit provided on the Osbourne base board. HDMI power switch and I2C translation is provided on the IO board.

9.3.4 Audio

Audio I/O signals from the Osbourne base board include stereo line out and mono mic in terminated on the I/O connector. The audio signals on the I/O connector board are terminated onto a 2x5 header.

9.3.5 Serial Ports and DIO

Serial port 1 capable of RS232/RS422/RS485 is made available on bottom port of dual DB9 connector

Serial port 2 capable of RS232/RS422/RS485 or 8 DIO's with 5V/3.3V level are made available on top port of dual DB9 connector. Interface is jumper selectable or software configurable.

For Jumper settings refer CAN/Serial/DIO Jumper (JP1)

9.3.6 Serial Ports and CAN

Serial port 3 (RS232) and port 4 (RS232) are muxed with CAN port 1 and port 2 respectively are terminated at dual RJ11 connector. Interface are jumper selectable or software configurable. At a time both CAN ports or both Serial ports or one serial and one CAN port can be selected.

For Jumper settings refer CAN/Serial/DIO Jumper (JP1)

9.3.7 USB

Board has two vertically stacked USB3 Type A connector. J13 connector provided 2x USB3.2/USB2.0 connectivity. Bottom port of J23 can be used for programming the Orin module when in recovery mode. Top Port of J14 connector provides only USB2.0 connectivity routed through USB hub of Osbourne base board and Bottom port of J14 connector provides USB 3.2/USB2.0 connectivity directly from the module.

9.3.8 Utility

Some of the additional interfaces like Power button, Reset, I2C (3.3 V), SPI (3.3 V) and Force recovery signals are available through a 2x5 utility header

9.4 Connector Pinout Specification

9.4.1 Power In (J17)

The pinouts for power input are as shown below:

VIN	1
	3
GND	2

+VIN = +7V to +20V

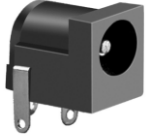
Connector PN: PJ-202BH Mating Cable PN: Standard 2.5mm DC plug	
---	--

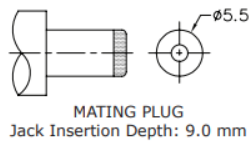

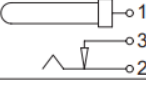
SCHEMATIC	
Model	PJ-202BH
Center Pin	Ø2.5 mm

Optional latching 2x2 IPI1 series power connector can be populated instead of Power jack. Please contact DSC support for custom build.

9.4.2 Main I/O Connector (J1)

Refer to section Main I/O Connector (J4) for Pinouts.

Connector on IO Board: Samtec ERF8-075-01-L-D-RA-L-TR	
---	--

9.4.3 HDMI (J12)

Vertical RA type A HDMI connector is available on the board. The signals are routed from the main board through I/O connector

The pinouts for power input are as shown below

HDMI_DP2_TX0_CON_P	1
GND	2
HDMI_DP2_TX0_CON_N	3
HDMI_DP2_TX1_CON_P	4
GND	5
HDMI_DP2_TX1_CON_N	6
HDMI_DP2_TX2_CON_P	7
GND	8
HDMI_DP2_TX2_CON_N	9
HDMI_DP2_TX3_CON_P	10

GND	11
HDMI_DP2_TX3_CON_N	12
HDMI_CEC_CON	13
RSRVD	14
HDMI_SCL_CON	15
HDMI_SDA_CON	16
GND	17
V_5P0_HDMI	18
HDMI_HPD_CON	19

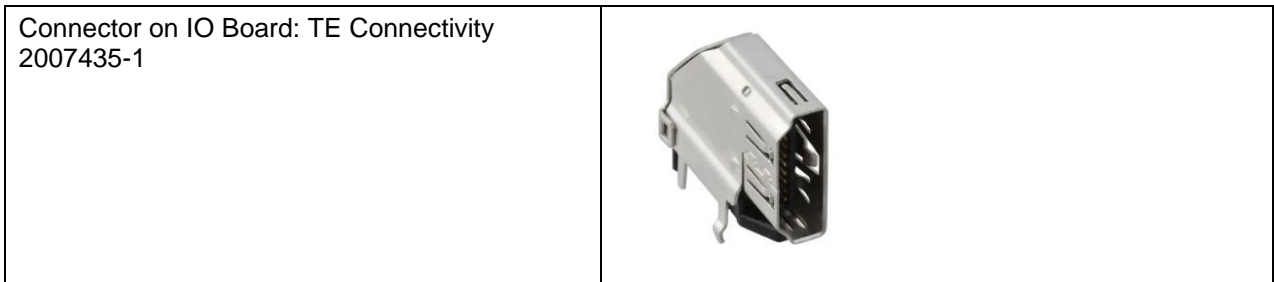

9.4.4 Two Dual USB Port (J13, J14)

Two vertically stacked USB 3.2 port are provided on the commercial board with signals are routed form the board through I/O connector

J13 pinouts are as shown below:

V_USB3_2	1
USB2_D0_CH_N	2
USB2_D0_CH_P	3
GND	4
USB3_UPHY_RX1_N	5
USB3_UPHY_RX1_P	6
GND	7
USB3_UPHY_TX1_N	8
USB3_UPHY_TX1_P	9
V_USB3_3	10
USB2_D1_CH_N	11
USB2_D1_CH_P	12
GND	13
USB3_UPHY_RX20_N	14
USB3_UPHY_RX20_P	15
GND	16
USB3_UPHY_TX20_N	17
USB3_UPHY_TX20_P	18

J14 pinouts are as shown below:

V_USB3_1	1
USB2/PCIE_CLK_CH_N	2
USB2/PCIE_CLK_CH_P	3
V_GND_RST	4
USB3/PCIE_UPHY_RX0_N	5
USB3/PCIE_UPHY_RX0_P	6
GND	7
USB3/PCIE_UPHY_TX0_N	8
USB3/PCIE_UPHY_TX0_P	9

V_USB2_VBUS	10
USB2_HUB_D4_CH_N	11
USB2_HUB_D4_CH_P	12
GND	13
NC	14
NC	15
GND	16
NC	17
NC	18

Bottom port of J13 can be used for module programming purpose and Top port of J14 supports only USB2.0 interface.

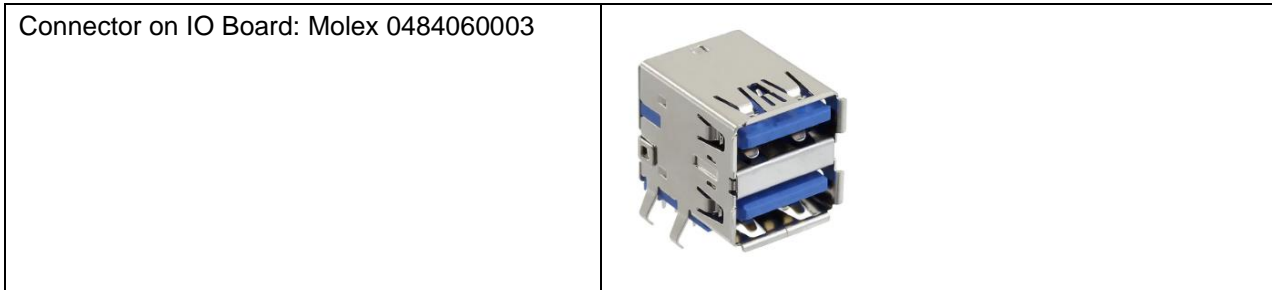

9.4.5 1G Ethernet + 10G Ethernet (J10)

Dual Port vertically stacked RJ45 connector with inbuilt magnetics are used. The passive components of Led are mounted on the commercial board and MDI signals are routed from main board through I/O connector.

The pinouts are as shown below

GBE_MDI0_P	T1	MGBE0_PHY_A_P	B1
GBE_MDI0_N	T2	MGBE0_PHY_A_N	B2
GND	T3	GND	B3
GBE_MDI1_P	T4	MGBE0_PHY_B_P	B4
GBE_MDI1_N	T5	MGBE0_PHY_B_N	B5
GND	T6	GND	B6
GBE_MDI2_P	T7	MGBE0_PHY_C_P	B7
GBE_MDI2_N	T8	MGBE0_PHY_C_N	B8
GND	T9	GND	B9
GBE_MDI3_P	T10	MGBE0_PHY_D_P	B10
GBE_MDI3_N	T11	MGBE0_PHY_D_N	B11
GND	T12	GND	B12
V_3P3	T13	V_3P3	B13
KSZ_LED1	T14	MGBE0_LED0	B14
KSZ_LED2	T15	V_3P3	B15
V_3P3	T16	MGBE0_LED2/ MGBE0_LED1	B16

<p>Connector PN: G23-21YR-112 Mating Cable PN: Standard CAT6A cable for 10G and Cat5 cable for 1G port</p>	
---	--

9.4.6 Audio (J2)

This connector provides the analog audio interface from the IO connector. The pinouts are as shown below:

AUDIO_HPOL_HDA	1	2	AUDIO_HPOR_HDA
GND_AUD	3	4	GND_AUD
NC	5	6	NC
GND_AUD	7	8	GND_AUD
AUDIO_MIC_L	9	10	AUDIO_MIC_R

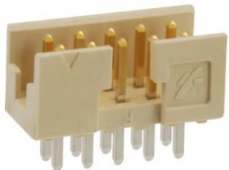
<p>Connector type: 2x5 2.54mm Header Connector PN: 98414-G06-10LF</p>	
--	---

9.4.7 Serial Ports/DIO (J16)

The serial ports 1 is routed to at dual DB9 bottom port. Serial port 2 muxed with DIO is terminated at dual DB-9 top port. By default, Top port supports GPIO interface and bottom port support Serial port. Configuration can be changed using CAN/Serial/DIO Jumper (JP1).

A dual DB9 connector pin out for DIO is below

PA0	A1	B1
PA1	A2	B2
PA2	A3	B3
PA3	A4	B4
GND_DIG	A5	B5
PA4	A6	B6
PA5	A7	B7
PA6	A8	B8
PA7	A9	B9

A dual DB9 connector pin out for serial 1-2 RS232 protocol is below

	A1	B1	NC
RX2	A2	B2	RX1
TX2	A3	B3	TX1
	A4	B4	
GND_DIG	A5	B5	GND_DIG
	A6	B6	
RTS2	A7	B7	RTS1

CTS2	A8	B8	CTS1
	A9	B9	

A dual DB9 connector pin out for Serial 1- 2 RS422 protocol is below

	A1	B1	NC
RX2_P	A2	B2	RX1_P
TX2_P	A3	B3	TX1_P
	A4	B4	
GND_DIG	A5	B5	GND_DIG
	A6	B6	
TX2_N	A7	B7	TX1_N
RX2_N	A8	B8	RX1_N
	A9	B9	NC

A dual DB9 connector pin out for serial 1-2 RS485 protocol is below

	A1	B1	
	A2	B2	
RX2_P	A3	B3	RX1_P
	A4	B4	
GND_DIG	A5	B5	GND_DIG
	A6	B6	
RX2_N	A7	B7	RX1_N
	A8	B8	
	A9	B9	

Connector type: Dual DB9 Connector PN: ASUB-277-09TP23 Mating Cable PN: Standard DB9 Connector	
--	---

9.4.8 CAN/Serial Ports (J11)

The serial ports 3 - 4 are muxed with CAN 1 - 2 and terminated at dual RJ11 connector. By default, CAN interface is supported on both the ports. Configuration can be changed using CAN/Serial/DIO Jumper (JP1).

The pinouts for Serial 3-4 RS232 are as shown below:

	U1	B1	RS232_2_RTS*
RS232_1_TX	U2	B2	RS232_2_TX
RS232_1_RX	U3	B3	RS232_2_RX
	U4	B4	
GND_DIG	U5	B5	GND_DIG
	U6	B6	

The pinouts for CAN 0-1 are as shown below

	U1	B1	
	U2	B2	
CAN0_CON_L	U3	B3	CAN1_CON_L
CAN0_CON_H	U4	B4	CAN1_CON_H
GND_DIG	U5	B5	GND_DIG
	U6	B6	

*By default, 6P4C connector is mounted so pins 1 and 6 will not be accessible.

Top port RS232 can also be used for debug console purpose.

Connector PN: LPJE212XDNL Mating Cable PN: Standard	
--	---

9.4.9 Utility (J3)

The utility connector provides access to SPI and I2C. Both interfaces are 3.3V level. The pinouts are as shown below

V_3P3	1	2	I2C_GP8_CLK_3P3
BUTTON_POWER_ON_N	3	4	I2C_GP8_DAT_3P3
GND	5	6	SPI_CLK
SYS_RST_IN_N	7	8	SPI_MISO
SPI_CS0	9	10	SPI_MOSI

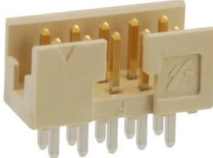
Connector PN: 98414-G06-10LF Connector Type: 2x5 2mm Header	
--	--

9.4.10 Battery Connector (J4)

Two Pin connector is used to connect the external battery. The pinouts are as shown below

V_3P0_RTC_CON	1
GND	2

Connector PN: 0022035025	
--------------------------	---

9.4.11 Push Buttons

Three push buttons are provided for various functions depicted below

Position	Function
RST	System Reset (SW1)
RCVRY	Force Recovery (SW2)
PWRBTN	Power ON Button (SW3)

Connector PN: 1BT018-10240-004-7F	
-----------------------------------	--

9.4.12 Remote control Power connector (J9)

A 2-pin connector is provided to supply the always on power to the external board for remote debug/control.

1	5V
2	Ground

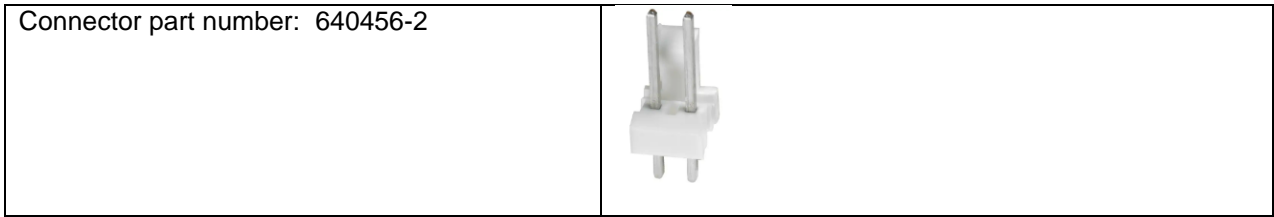

9.4.13 Miscellaneous header (J5)

A 8-pin 0.1" standard pin header with miscellaneous signals such power button, reset, recovery and memory erase (based on M.2 module support) are provided to connect external board for remote debug/control. All are open drain signals with 1.8V tolerant. Some of the

1	Memory erase
2	Ground
3	Recovery
4	Ground
5	Power button
6	Ground
7	System reset
8	Ground

Connector part number: Standard 0.1" TH Pin header

10 CONNECTOR INFORMATION

10.1 Connector Table

The following table provides a summary of all I/O connectors on the board.

Function	Manufacturer	Part no.	Description	DSC Mating Cable
Power in	CUI Inc.	PJ-202BH	Conn Pwr Jack 2.5x5.5mm Solder	Standard
Main I/O Connector	Samtec	ERF8-075-01-L-D-RA-TR	2x75 0.8mm pitch R/A SMD	Standard
HDMI	TE Connectivity	2007435-1	HDMI type A	Standard
1G/10 Ethernet	Bel	G23-21YR-112	RJ 45 CONN Dual Stacked with inbuild magnetics	Standard
USB	Molex	0484060003	Conn Rcpt Usb3.0 Type A Stack R/A	Standard
Audio	Amphenol	98414-G06-10LF	Connector Header Through Hole 10 position 2.00mm	6980608
Serial Ports/GPIO	Assmann	ASUB-277-09TP23	9 Position D-Sub - Stacked Plug, Male Pins Connector	Standard
CAN/Serial Ports	Link-PP	LPJE2120DNL	2x1 RJ11 6p4c connector without integrated magnetics	Standard
Utility	Amphenol	98414-G06-10LF	Connector Header Through Hole 10 position 2.00mm	Standard
Push Buttons	Foxconn	1BT018-10240-004-7F	Side-push SMT type Tact switch	NA
Battery connector	Molex	0022035025	CONN HEADER VERT 2POS 2.5MM	6980524

11 B2B 1G ETHERNET BOARD CONNECTOR

A standalone B2B add on RGMII adapter board used to convert the standard ethernet RGMII signal originated from module to MDI signals terminated on the standard RJ45 connector mounted on I/O board. Add on board has single port 1G speed ethernet PHY and related circuitry. MDI signals are routed through Osbourne Baseboard 150 pin I/O connector to commercial I/O board.

For Connector and Pin out detail of Refer [RGMII Adapter Connector \(J9\)](#) Section

11.1.1 Mechanical Drawing

The Mechanical outline of board is depicted below. The board has a form factor of 22 x 24 mm

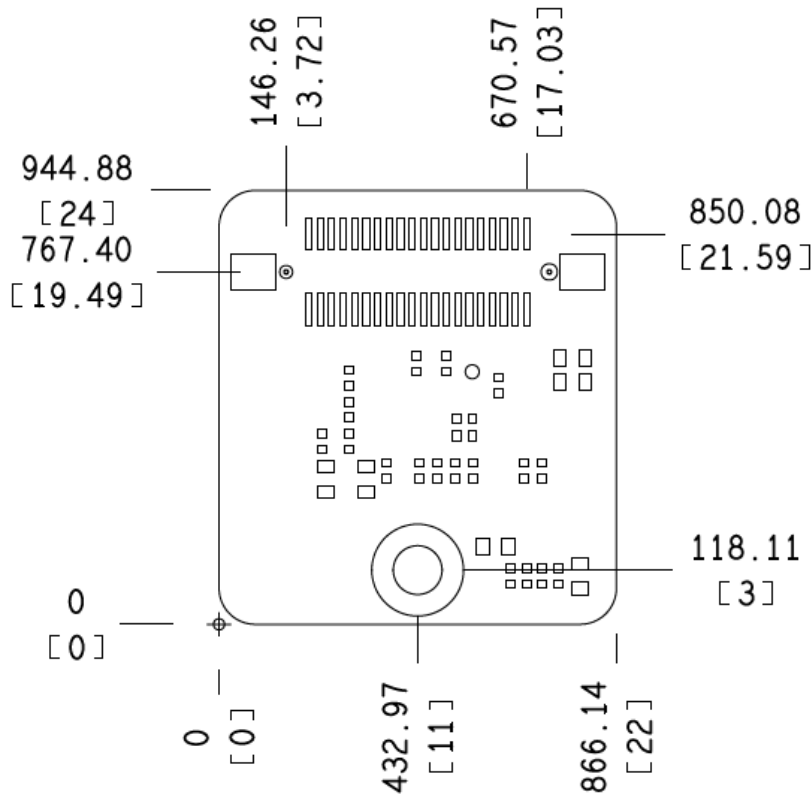

Figure 4: Mechanical outline of RGMII Board

12 SPECIFICATIONS

The baseboard specifications are summarized in the following table.

<i>Feature</i>	<i>Brief Description</i>
Module	AGX Orin Series
CPU	12-core Arm® Cortex®-A78AE v8.2 64-bit CPU 3MB L2 + 6MB L3
SDRAM Memory	64GB 256-bit LPDDR5 204.8GB/s
Display	1x HDMI 2.0a/b
USB Ports	4x USB 2.0, 3x USB 3.2
Serial Ports	2 x ports Software configurable RS-232/422/485 2x ports fixed RS-232
Camera	4 x4 / 8 x2 lane CSI-2 Camera Interface
Ethernet	1G/2.5G/5G/10G Multi Mode Gigabit Ethernet without on board Magnetics 10/100/1000Mbps through RGMII adapter board without on board Magnetics
Mass Storage	2x mPCIe socket 1 M.2 M Key (2280 or 2242) (NVMe) expansion slots (4 lane PCIe Gen 3) 1 M.2 E key 2230
Audio	Audio output and Mic In
CAN	2x CAN with Non isolated transceivers
RTC	3V power input for RTC functionality
Digital I/Os	8 Digital IO
Fan	Active Thermal Solution with PWM & Tach Input
Utility	PWR_BTN, RESET, FORCE RECOVERY, I2C(3.3V), SPI(3.3V)
<i>Electrical, Mechanical and Environmental Properties</i>	
System Input Voltage	+7VDC +/-5% to +20VDC +/-5%
Power Consumption	~65W (TBU)
Dimensions	120mm x 115mm
Weight	TBU
Operating Temperature	-25°C to +80°C
RoHS	Compliant

13 LIMITED WARRANTY

Diamond Systems Corporation warrants that its products will be free from defects and errors in material and workmanship and perform in full accordance with the technical specifications stated in the description of the product for a duration of 2-Year Period from the Date of Shipment.

Unless otherwise stated, Diamond Systems Corporation Limited Warranty Policy covers the following criterion.

- It is extended to the original Purchaser/Consumer.
- Under Terms and Conditions of the Warranty, Diamond Systems Corporation, at its sole discretion, will repair or replace any defective parts or components of its product.
- The product must be returned to Diamond Systems Corporation in the-approved packaging, pre-authorized with a Diamond Systems Corporation-assigned Return Material Authorization (RMA) Number which is referenced on the shipping document.
- The Customer will prepay the shipment cost of the product to the Diamond Systems Corporation designated site.
- Diamond Systems Corporation will prepay the return shipping cost of the repaired or replaced the RMA product.

Diamond Systems Corporation Limited Warranty Policy does not cover product defects or damages incurred due to:

- Attempts by Customer to repair or resolve any product issues without the prior consent of Diamond Systems Corporation.
- Mishandling, misuse, neglect, normal wear, and tear, or accident.
- DIRECT, SPECIAL, INCIDENTAL OR CONSEQUENTIAL DAMAGES RESULTING FROM ANY BREACH OF WARRANTY OR CONDITION, OR UNDER ANY OTHER LEGAL THEORY, INCLUDING BUT NOT LIMITED TO LOST PROFITS, DOWNTIME, GOODWILL, DAMAGE TO OR REPLACEMENT OF EQUIPMENT AND PROPERTY, ANY COSTS OF RECOVERING, REPROGRAMMING, OR REPRODUCING ANY PROGRAM OR DATA STORED IN OR USED WITH DIAMOND SYSTEMS CORPORATION PRODUCTS, AND ANY FAILURE TO MAINTAIN THE CONFIDENTIALITY OF DATA STORED ON THE PRODUCT.

NOTE: THE LIMITED WARRANTY POLICY DOES NOT WARRANT TO REPAIR ANY OR EVERY DIAMOND SYSTEMS CORPORATION PRODUCT.
